

DEHUMIDIFIER

MODEL

MJ-E82GH-H

INSTRUCTION MANUAL

English

E

Features

- Supplement Air for Drying Indoors
- Drying Inside
- Air Filter and Silver Ion Sterilising and Deodorising Filter
- Easy Dehumidifying · Intelligent Laundry







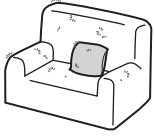











Table of Contents page

● Recommended Ways of Using the Unit Depending on Purpose.....	2	Before Using the Unit
● Frequently Asked Questions.....	3	
● Precautions.....	4	
● Warnings.....	6	
● Tips on Dehumidifying.....	6	
● Names and Functions of Parts.....	7	
Unit/Control Panel/LCD Panel (Low Temperature/Defrost/High Humidity)		
● Things to Be Aware of	10	
● Before Using Your Dehumidifier ...	10	
<hr/>		
● Turning the Unit ON and OFF.....	12	Operating
To turn ON/To turn OFF Reading the humidity display/Tank full lamp		
● Easy Operation	13	
EASY DEHUMIDIFYING/INTELLIGENT LAUNDRY		
● Setting Modes.....	14	
LOW/MILDEW GUARD/LOW TEMP/AUTO/AIR PURIFIER		
● Swing Louvre Function.....	16	
● Drying Inside	17	
● Using the Timer	18	
OFF timer operation/ON timer operation		
● Using the Child Lock.....	20	
● Carrying the Unit	20	
● Removing Water from the Tank... ..	21	
● Continuous Drainage.....	22	
<hr/>		
● Maintenance	23	Troubleshooting
● Replacing Consumable Parts.....	25	
● Storage and Disposal.....	25	
● Troubleshooting	26	
● Specifications	28	

- In order to ensure correct usage, please read this instruction manual carefully and retain it for future reference.
- Before accepting the Warranty at the time of purchase, please make sure that the date of purchase, place of purchase and other items are correctly filled in the form.

Recommended Ways of Using the Unit Depending

Combine operating mode and swing louvre function to get optimum results.

Objective	<h2>Drying laundry</h2> <p>When you don't want to hang clothes outside or it is raining...</p> 	<h2>Lowering room humidity</h2> <p>When you don't know what humidity level to set the unit to...</p>  <p>When you want to set the humidity level...</p> 		<h2>Preventing mould/</h2> <p>When condensation occurs indoors...</p>  <p>To prevent mildew...</p> 	
Recommended operating mode	INTELLIGENT LAUNDRY The unit operates automatically until the laundry is dry.	EASY DEHUMIDIFYING The unit operates until the air is comfortable.	AUTO The unit maintains the set humidity.	LOW TEMP The unit changes the airflow according to room temperature.	MILDEW GUARD The unit operates in mildew suppression mode.
Recommended swing setting	UPWARD Aim toward clothes.	Any swing setting		Any swing setting	
Procedure Press the power button (the unit turns on) Page 12 Select the mode Page 13-15 Select the louvre swing range Page 16	 Turn the power on  Select INTELLIGENT LAUNDRY  Select UPWARD	 Turn the power on  Select EASY DEHUMIDIFYING  Switch to HUMIDITY SELECTION  Set the humidity  Select any swing setting		 Turn the power on  Select MILDEW GUARD  Select any swing setting	

condensation

To keep the inside of closets and shoeboxes dry...

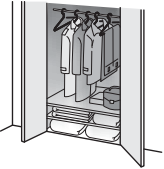

To clean the air

There is no need for dehumidification, but you wish to remove pollen and dust from the air.



LOW

The dehumidifier operates regardless of the humidity level.

REAR

Direct the air flow



AIR PURIFIER

The unit operates the air purifier only.

Any swing setting



Turn the **power on**



Switch to **AIR PURIFIER**



Select any swing setting

Select **LOW**

Select **REAR**

Q. Why does the dehumidifier seem to collect less water in winter?

A. When the temperature and humidity are low, the amount of water collected is decreased.

In winter, because the temperature is lower than in summer, the effects of the dehumidifier decrease dramatically as shown in the graph below. Although less water collects in the tank, this is not a malfunction.

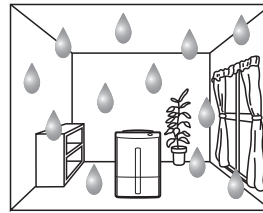

Summer (humidity)

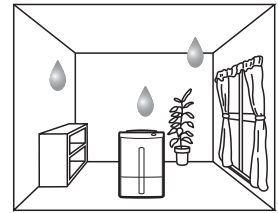

Winter (dampness)

* If the temperature is low, but the humidity is high due to snow or rain, operating the unit in **LOW TEMP** mode will yield better results than in **LOW** mode. 14

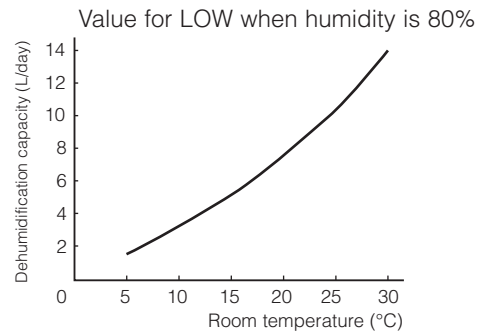

• The values shown on the graph were measured at constant temperature and humidity and do not reflect values obtained in actual usage conditions.

Q. • Why doesn't the dehumidifier operate? • Why does the unit stop operating suddenly?

A. The unit might be in INTELLIGENT LAUNDRY mode.

The unit may sometimes stop operation after just a short amount of time as a result of conditions such as the room temperature and humidity. 13

A. The unit might be in EASY DEHUMIDIFYING, MILDEW GUARD, or AUTO mode.

The unit automatically switches between dehumidifying, airflow only, and non-operation. 13-15

Precautions

The following diagrams indicate circumstances where danger can result from mishandling the unit.



WARNING

Mishandling may result in fatal or serious injuries.



CAUTION

Mishandling may result in injuries or damage to your home or property, etc.

Meanings of the graphic symbols used in this manual and on the unit are explained below.



Forbidden



Do not disassemble



Always follow the instructions



Keep away from fire



Do not subject to water



WARNING

Do not start/stop the unit by plugging/unplugging the power cord.



This may result in **fire and/or electric shock**.

Do not use extension cords or multiple head adapters.



This may result in **fire, electric shock or malfunctions**.

Do not damage or modify the power cord or plug.

Do not modify, bundle, twist, bend or heat the power cord. Do not place under objects or use with the end close to the plug bent.

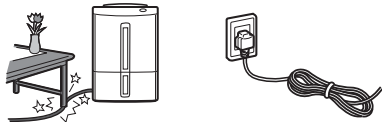

The cord may be damaged resulting in **fire or electric shock**. (Keep pets from biting the cord.)

Do not put your fingers or any long object, into the air intake/outlet. Do not touch the swing louvre.



The internal fan rotates at high speeds, and such actions may result in **injury or malfunctions**.

Do not attempt to repair, disassemble, or modify the unit.

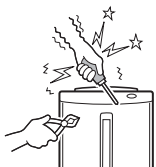

This may result in **fire and/or electric shock**. Refer servicing to your dealer or Mitsubishi Electric Service Centre.

Do not put the unit near heat-generating devices (such as stoves, fan heaters, etc.).

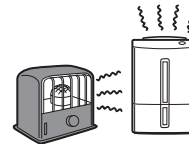

The plastic parts may **melt and cause fire**.

Wipe dust off the power plug and insert the plug firmly.

If the plug is not fully inserted into the socket, dust may gather on the connectors which may cause **fire and/or electric shock**.



Use 220V AC power sockets.

Connecting to power sockets other than 220V AC may result in **fire and/or electric shock**.



Remove water that has collected in the tank.

Accidentally drinking the water or using it for other purposes may cause **illness and/or unforeseen accidents**.



Should abnormal symptoms occur (a burning smell, etc.), switch off the unit and unplug it from the socket.

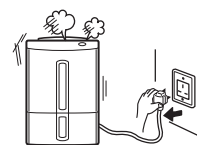

Continuing to operate the unit may result in **fire, electric shock, or malfunctions**. Contact your dealer or Mitsubishi Electric Service Centre for consultation.

CAUTION

Do not cover the front or side air intakes or the air outlet with cloth, curtain, etc.

This results in poor ventilation and may cause **heat generation/fire**.

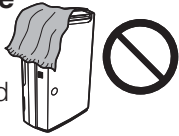

Do not stand on, sit on or lean against the unit.

The unit may tip over causing **injury**.



Do not put vases or any other objects filled with water on the unit.

Water may leak into the unit adversely affecting electric insulation and cause **electric shock and/or fire by short-circuiting**.



Do not use the unit where it may be exposed to direct sunlight or other weather conditions. (This unit is for indoor use only.)

This may cause **overheating, electric shock and/or fire caused by an electric leak**.

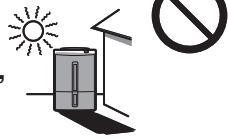

Do not use the unit in narrow, enclosed places such as inside closets, between pieces of furniture, etc.

This results in poor ventilation and may cause **heat generation and/or fire**.



Do not use combustion appliances in the path of the air outlet.

This may cause **incomplete combustion** in the appliance.

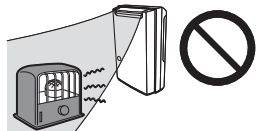

Do not use the unit in places where chemicals are used (such as hospitals, factories, laboratories or beauty salons).

Chemicals and solvents evaporated in the air may harm the unit and cause water in the tank to leak, **resulting in damage to property**.



Do not use the unit for special purposes, such as preservation of food, art or scientific works.

This may negatively affect the **quality of the items stored**.



Do not drain water continuously if there is a possibility that temperature around the hose could drop to freezing point.

Water inside the hose may freeze and prevent the water in the tank from flowing out. The water may leak from the unit and **damage surrounding objects**.



Do not use the unit in places that may be subject to oil or flammable gas leakage.

Such a leak around the unit may cause **combustion and fire**.



Do not remove the Styrofoam from the floating element.

The floating element will not be able to detect a full tank resulting in water leakage, which may **damage surrounding objects or cause electric shock and/or an electric leak**.

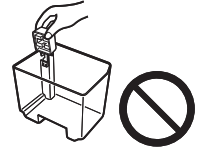

Do not wash the unit with water. Do not use the unit where it is likely to come in contact with water.

Exposure to water may result in **fire or electric shock caused by an electric leak**.



Do not point air-flow from the unit directly at the body.

If air-flow is directed at the body for long periods, it may **harm one's physical condition and lead to dehydration**.



Keep the supplement cartridge out reach of children.

Do not disassemble or tear the bag inside the cartridge. Make sure children do not swallow the contents.



Install the unit in a location where the floor is flat and stable.

If the unit falls over, the water collected in the water tank may leak damaging surrounding objects and in turn result in **fire or electric shock caused by an electrical leak**.



Grasp the plug and remove from the power socket.

When removing the plug from the power socket, do not pull on it diagonally or by the cord as this may cause the projections/wiring to be **damaged resulting in a short circuit, electric shock or fire**.



Before moving the unit always switch it off, unplug it and remove water from the water tank.

Moving the unit with water in its tank may cause the water to leak and **damage the surrounding objects and in turn result in electric shock and/or an electric leak**.



Precautions (Cont.)

CAUTION

After emptying the tank, transport the unit by grasping the handle firmly.

Losing your footing while carrying the unit may cause **personal injury** or **damage to the floor**.



When using the continuous drainage outlet, make sure to position the hose so that the water drains without obstruction.



The water in the tank may leak and **damage surrounding objects**.

When draining water continuously or left unattended for long periods, inspect the unit every two weeks.



Do not allow debris to clog the filter/hose as this may cause **overheating/leakage**.

Use the unit with caution in rooms where the walls, furniture and art work are vulnerable to dry air, as it may cause **cracks and warping**.



Switch the unit off and unplug from the power source when cleaning it.

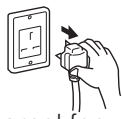

When the unit is on, the internal fan rotates at high speeds and may cause **injury**.

Unplug the unit from the power source when not using the unit for an extended period of time.



Otherwise it may cause **fire and/or electric shock** caused by an electric leak.

Tips on Dehumidifying

Drain the water tank before use

Refrain from opening doors/windows during operation

Drying laundry indoors

- Direct the louvres at the laundry.
- Space laundry to improve airflow.



Maintain room temperature above 16°C with a heater

- Drying times will vary depending on the nature of the laundry and the room temperature.
- The airflow is strongest to the top right of the unit.

Installing your dehumidifier

Make sure to leave some space around the unit.

<For use in close proximity to a wall>

Stop the louvre in the vertical position. Blowing air at the wall may cause staining.

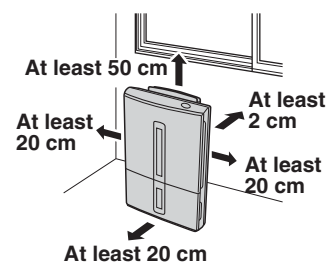

Operating noise

Place the unit on top of a mat. This reduces vibration and noise. It also prevents leaving depressions on carpets.

Warnings

- **Keep the unit always in an upright position.** Inclining the unit may cause water in the tank to leak into the unit, **resulting in malfunction**. Should this happen contact service number on the last page for advice.
- Damage to the dehumidifier caused by atmospheric conditions (ie. Salt or Sulphur) will not be covered under warranty.

- **Do not carry or store the unit horizontally.** This may **result in malfunctions**. Such malfunctions are NOT covered under warranty.

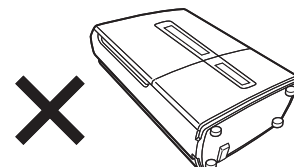

Names and Functions of Parts

Front

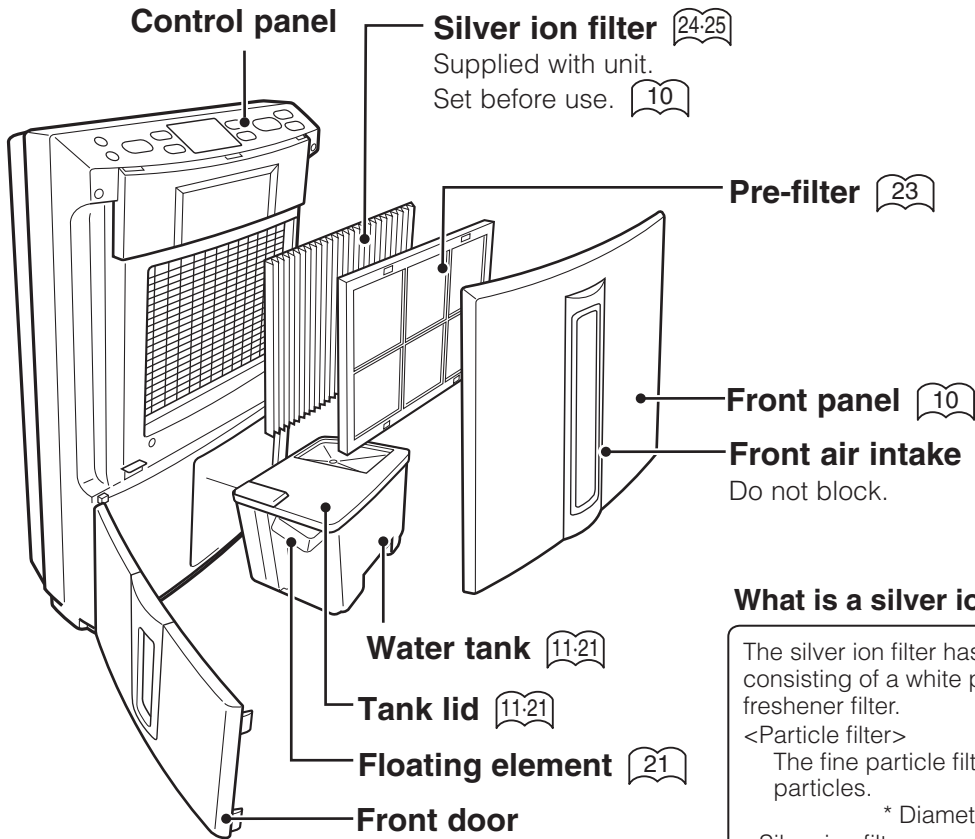

What is a silver ion filter?

The silver ion filter has a two-layer construction consisting of a white particle filter and a blue air-freshener filter.

<Particle filter>

The fine particle filter removes pollen* and dust particles.

* Diameter of pollen: approx. 10–100 µm

<Silver ion filter>

A special deodorant and anti-bacterial agent (anti-allergen, anti-virus and sterilisation) are contained in the fibres of the silver ion filter.

Cigarette smoke and toxins found in smoke, such as carbon monoxide, cannot be removed with this filter.

Back

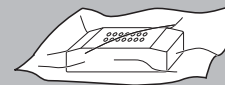
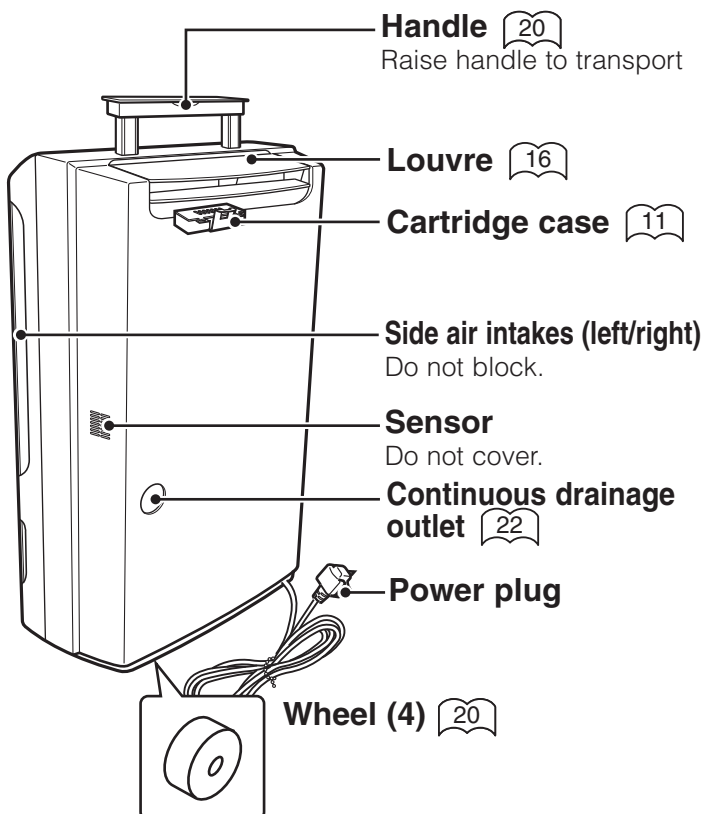

Supplement cartridge 11
Supplied with unit. Set before use.

What is supplement air?

Recognizing the antioxidant qualities of natural herbs, we put the oil extracted from rosemary, which has exceptional antioxidant qualities, into the air outlet cartridge. The fragrance is so slight that it can be hardly noticed.

The reason washing yellows is because colourless organic material trapped within the fibres is oxidized by heat from a drier or the sun's UV rays. By using the dehumidifier and drying your washing indoors, you can keep away the oxidizing effects of heat and UV rays, as well as benefit from rosemary's antioxidant properties, preventing your clothes from yellowing.

The water tank may contain water residue at time of purchase. This is from final product testing at the factory and is not due to a defect.

Names and Functions of Parts (Cont.)

Control Panel

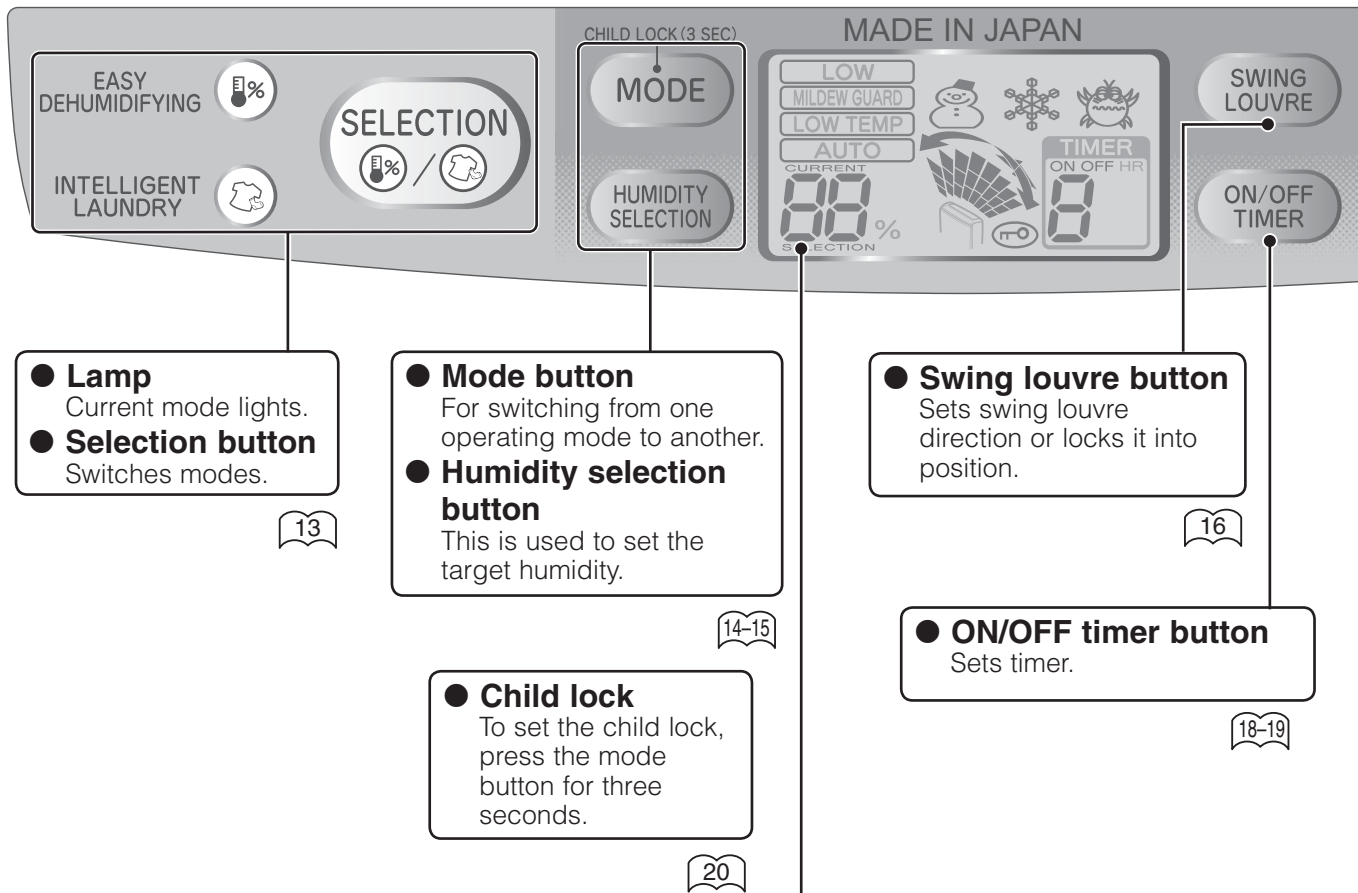

LCD Panel

All indicators on the LCD panel shown below.

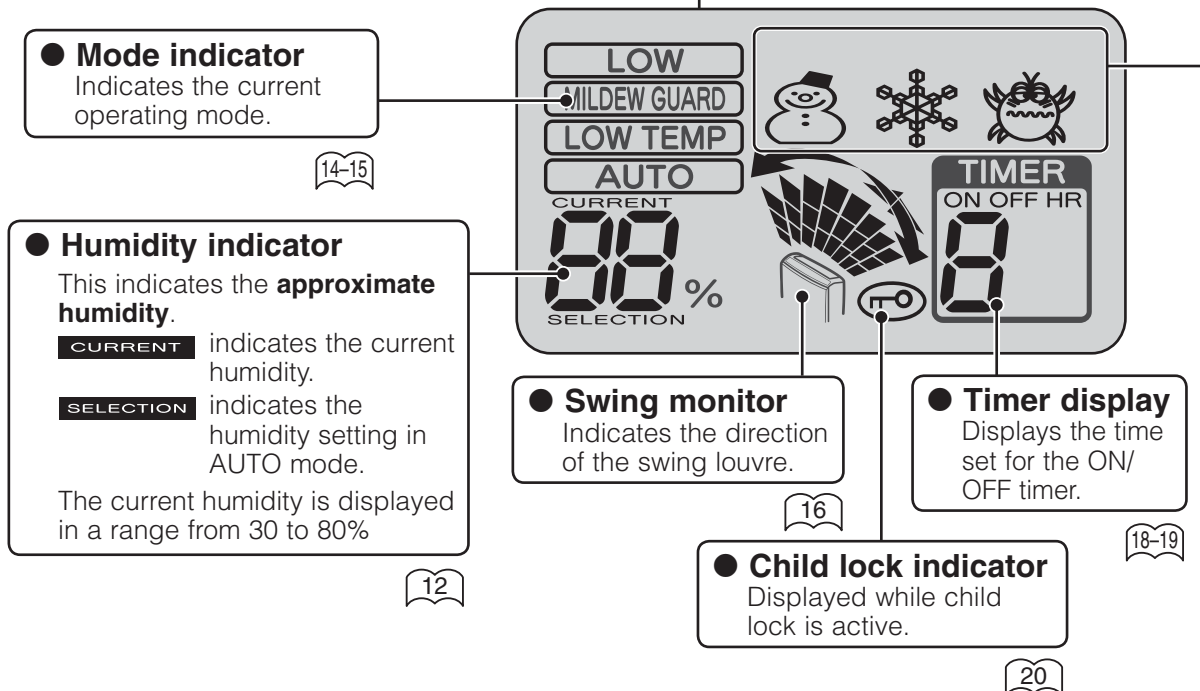

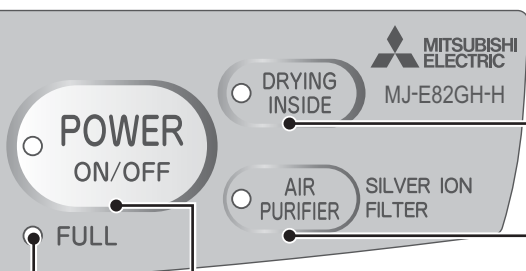

- **Drying inside lamp**
Flashes when drying inside in progress.
- **Drying inside button**
Activate/deactivates drying inside.

17

- **Air purifier lamp**
Lights during air purifier only operation.
- **Air purifier button**
Switches to air purifier only operation.

15

- **Power lamp**
Lights when unit is ON.
- **Power button**
Use this to switch the unit ON and OFF.

12

- **Tank full lamp**
This lights up to warn that the water tank is full.

12

You can select from 7 operating modes.

- **EASY DEHUMIDIFYING**
 - **INTELLIGENT LAUNDRY**
 - **LOW**
 - **MILDEW GUARD**
 - **LOW TEMP**
 - **AUTO**
 - **AIR PURIFIER**
- All modes include dehumidifier and air purifier functions.
- Air purifier only operation. The dehumidifier function is disabled.

- **Information display**
Indicates room and unit condition



Low Temperature Indicator

The  indicator comes on if the room temperature drops below 15°C. Activating LOW TEMP mode is recommended. 14

DEFROST Indicator

Airflow (dehumidifying) will stop and the frost that has accumulated inside will be melted and dropped into the tank when the  indicator is on. Please wait a moment as operation will resume in around 5 minutes.
While in DEFROST mode, airflow (dehumidifying) and the louvre will stop. The sounds coming from the unit will also change.
 DEFROST will start automatically when room temperature drops below 15°C (This may be as often as once every 40 minutes).

High Humidity Warning

The  indicator flashes when the unit is OFF and the humidity in the room exceeds 75%. Activating the dehumidifier is recommended when the  indicator is flashing.
 If the High humidity warning is not required, remove the power plug from the power socket.

Things to Be Aware of

Room temperature may rise 2-4°C during operation

The dehumidifier does not have a cooler function. Due to heat produced during operation, the room temperature may rise 2-4°C. As a result, the unit may blow warm air, but this is not due to a malfunction. During winter, the air may not feel warm as the temperature is below body temperature.

How does the dehumidifier work?

If you pour cold water into a cup, the air around it becomes cold, causing water droplets to form on the surface of the cup.

The dehumidifier takes advantage of this phenomenon to remove moisture from the air.

- ① The unit draws air from the room, cools it with its cooling coil, causing the moisture to transform into water droplets.
- ② The water droplets fall into the water tank.
- ③ **The dehumidified air is reheated by the heating coil, and then discharged.**

The humidity of the room is thus reduced by repeating steps ①, ②, and ③.

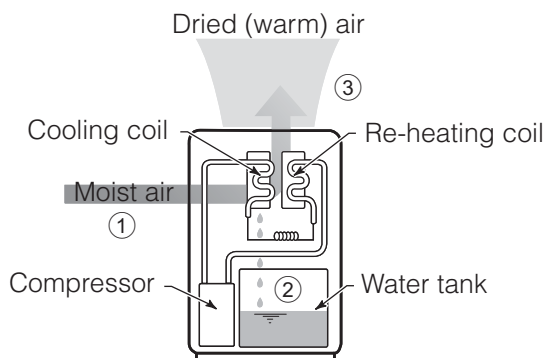

The humidity reading on the unit may differ from a hygrometer in the same room

Even in the same room, temperature and humidity levels may differ from place to place. If the hygrometer and the unit are in different parts of the room, the humidity levels are prone to differ. Moreover, humidity levels differ between places that have good and no airflow.

Use the reading on the unit as an estimate.

Why are they different?

<Cause>

- Inconsistencies in temperature and humidity
- Difference in location
- Difference in hygrometer precision

Before Using Your

Setting the silver ion filter

The silver ion filter is supplied with the unit at time of purchase. Fit the silver ion filter before using the unit.

- 1 Remove the silver ion filter from the polyethylene bag.
- 2 Remove the front panel and pre-filter.

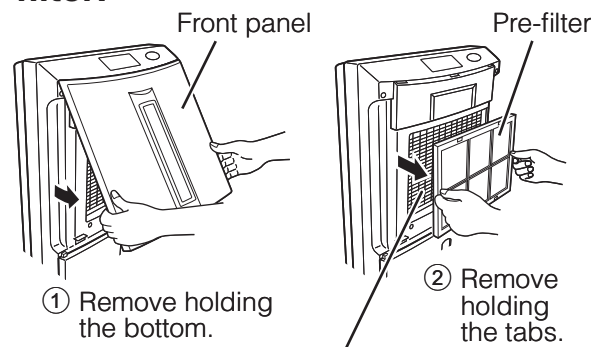

Performance is unaffected even if the metal fins inside the main unit are slightly bent.

- 3 Fit the silver ion filter into the pre-filter.

With the strips facing up, set the silver ion filter inside the tabs on the pre-filter.

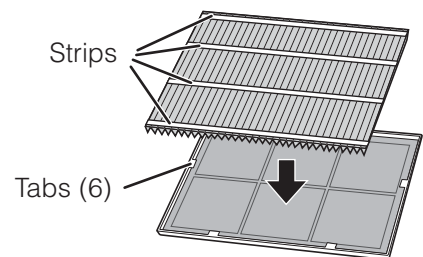

- 4 Attach the pre-filter and front panel.

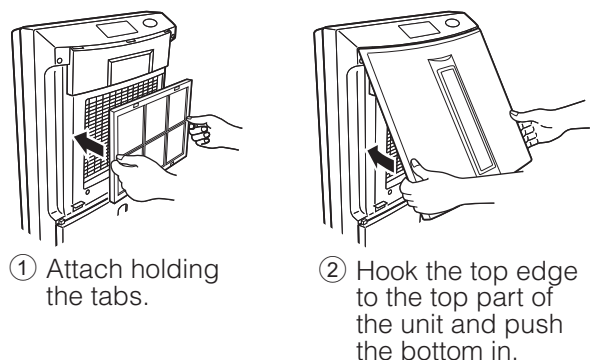

Dehumidifier

Setting the supplement cartridge

The unit disperses antioxidants during dehumidifier and air purifier operation by setting the supplement cartridge.

1 Remove the case.

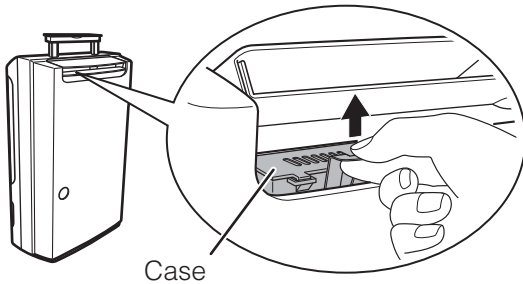

2 Remove the cartridge from the bag and set in the case.

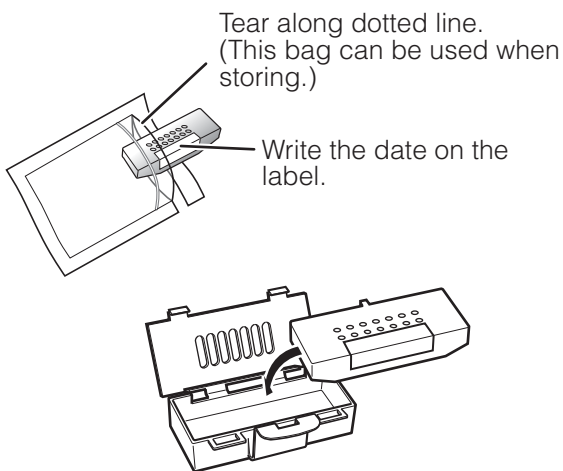

3 Set the supplement cartridge.

Move the louvre by hand to confirm that the case does not touch the louvre.

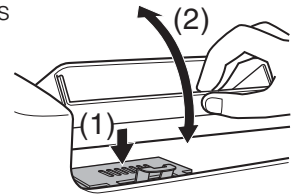

Note

- Do not disassemble or tear the bag inside the cartridge.
- Follow the procedures described above.

Information

- The unit can be operated without the cartridge.
- The unit can be operated with an expired cartridge, but will lack antioxidant properties.
- The herbal oil used in the cartridge is only slight fragrant, and is hard to detect.
- Use the original bag when storing the cartridge after a short use (1-2 months).

Cartridge life

Replace the cartridge after 6 months (not including the time it is stored in the bag). Replacement cartridges available for purchase. 

Only the cartridge is replaced. Do not throw away the case.

CAUTION

Keep the supplement cartridge out reach of children. Do not disassemble or tear the bag inside the cartridge. Make sure children do not swallow the contents.

Inserting the water tank correctly

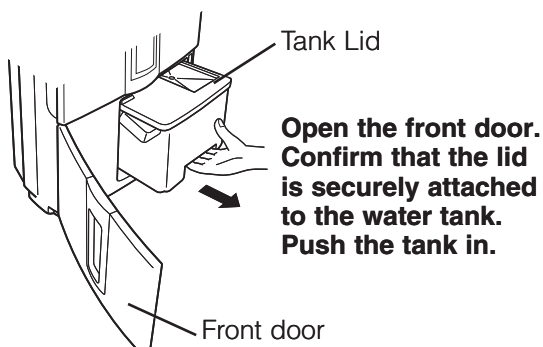

Plug the power cord into the power socket

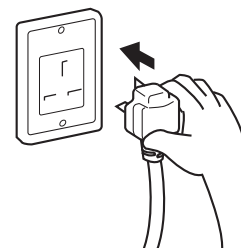

Use a 220V AC power socket only.

- The current humidity level is indicated.

If the louvre is open, it closes automatically.

E

Before Using the Unit

Turning the Unit ON and OFF

To turn ON

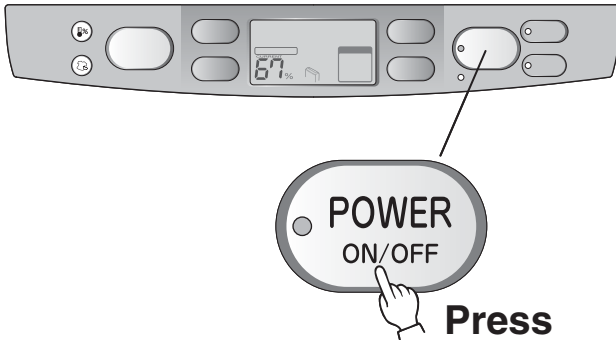

- Power lamp lights.
- The mode is displayed.
- The louvre opens automatically.

To start dehumidifying, select the desired mode.

13-15

The dehumidifier does not activate for 3 minutes when the unit is turned ON immediately after turning it OFF or plugging it into the power socket. (In order to protect the compressor.) When dehumidifying begins, the operational noise increases.

The dehumidifier remembers the operating mode. Even if the plug is disconnected or the power turned off, the unit restarts at the previous setting.

To turn OFF

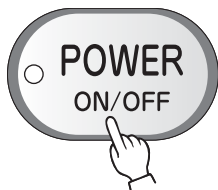

- Power lamp turns off.
- The Mode Indicator goes out.

Press

Drying inside will commence if it has been activated. 17

- If the room temperature falls below 15°C, defrosting mode is activated once every 40 minutes (for about 5 minutes) causing water to drain to the tank. 9
- The unit can operate in a room temperature range of 1-35°C. However, if the room temperature exceeds 35°C, the unit may operate in blower mode or increase the airflow. This is because the temperature within the unit rises causing the protection mechanism to operate. In order to lower the temperature within the unit, when using the louvre, point UPWARD.
- If the temperature is below 1°C, the extracted water is close to freezing disabling the dehumidifier, and only the blower is operational.

Information

Reading the humidity display

Example



CURRENT indicates the current humidity.

Current humidity range is between 30-80%.

- Humidity levels below 30% are displayed as 30%.
- Humidity levels above 80% are displayed as 80%.

Example



SELECTION indicates set humidity level (Auto mode only). 15

○ FULL Tank full lamp

The unit automatically shuts down and indicates with the lamp and sound that the water tank is full. Empty the water tank. 21

- Tank full lamp lights. (The unit beeps continuously.)
- Air flows stops (louvre stops).
- Swing monitor turns off.
- Compressor turns off.
- After removing the water and replacing the tank, the Tank full lamp will go off, and the unit will automatically return to operation mode.
- When the Tank full lamp is lit, no operation but ON/OFF is possible.

Easy Operation

The unit automatically monitors room temperature/humidity alleviating the necessity to make minor adjustments. Use EASY DEHUMIDIFYING for dehumidifying a room and INTELLIGENT LAUNDRY for drying clothes.



Changes with every press

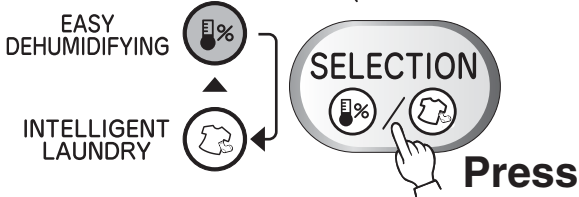

● Selected mode lamp lights.

● EASY DEHUMIDIFYING

The unit operates intermittently controlling the airflow to remove the damp feeling in the air. (There is no need to set the humidity level.)

When the room temperature is high, the blower operates to decrease the damp feeling.

The airflow or louvre operation may stop according to the humidity level.

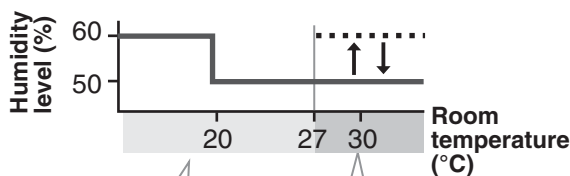

Room temperature is below 27°C - the unit automatically sets the humidity level according to the temperature.

Room temperature is above 27°C - the unit lowers the humidity level to 50%, then activates the blower. The dehumidifier is reactivated when humidity rises to 60%.

● INTELLIGENT LAUNDRY

The unit controls the airflow rate while monitoring the humidity in the room, and automatically stops operation when the laundry is dry. (This eliminates the need to make minor changes to the humidity and operating time settings depending on the amount of laundry.) Operation is performed for a maximum of approximately 12 hours.

Information

- **Drain the tank before use.**
The unit may stop before the laundry dries because of a full tank.
- **Do not use in conjunction with the OFF timer.**
The timer may turn the unit off before the laundry dries.
- **If the room temperature is approximately 5°C or less, the operation stops for around 1 hour.**
If the room temperature is low, it becomes difficult for water to evaporate from the laundry, because the humidity does not change. Use a heater in combination with the unit in order to raise the room temperature to approximately 16°C or more.
- **The following conditions prevent clothes from drying well:**
Room temperature below 15°C, large volume of laundry; laundry not spaced well; clothes of thick fabric and spacious room.

Information

Pressing Humidity Selection button while in EASY DEHUMIDIFYING or INTELLIGENT LAUNDRY mode changes the mode to AUTO.

Setting Modes

LOW, MILDEW GUARD and LOW TEMP

LOW mode is for when you want to leave the dehumidifier on. MILDEW GUARD mode suppresses mildew growth. LOW TEMP mode is for preventing condensation or when the room temperature is low.

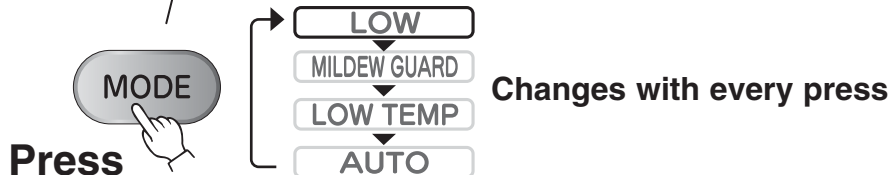

- Frame appears around selected mode.

- The amount of dehumidification decreases with the temperature and humidity.
- The humidity level cannot be set with LOW, MILDEW GUARD, and LOW TEMP.



- **LOW** The dehumidifier operates regardless of the humidity level.

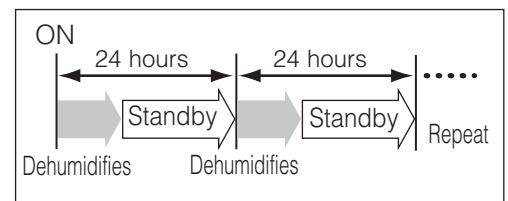

- **MILDEW GUARD** The unit lowers humidity levels automatically once a day, suppressing mildew growth.

- The unit operates intermittently for 2-4 hours a day (24 hours). The operating time varies depending on the humidity.
- The unit continues to operate when the humidity does not decrease.
 - Humidity 40% → Approx. 2 hours
 - Humidity 50% → Approx. 4 hours



Information

- Refrain from turning on ventilation fans or opening windows or doors as this lowers performance.
- Mildew growth may still occur due to the fungus type and conditions of the room. E.g. Rooms that contain excessive condensation, bathrooms, and places with bad airflow (insides of closets and behind furniture).
- This mode does not remove existing mildew.
- Do not use in conjunction with OFF Timer mode. Effects may not be achieved.

- **LOW TEMP** The unit operates continuously automatically controlling airflow according to room temperature. The air flow is strongest below 15°C. The use of LOW TEMP mode is recommended when the Low temperature indicator  is lit. 

Information

When the temperature is low, condensation may still form on windows exposed to the outside air even when LOW TEMP mode is operating.

How is mildew growth suppressed?

Mildew is unable to produce new spores if dried as mycelia. The Mildew Guard feature applies this principle. (However, the spores themselves are resilient to dry conditions.)

"Identification of Aspergillus and Penicillium"

<Research paper by Dr. K. Abe of the Environmental Biology Research Center>

AUTO

When you want to set the humidity level.

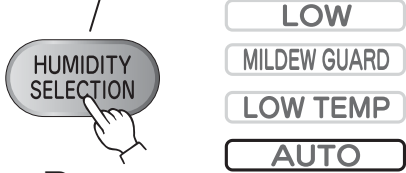

Press

- Frame appears around **AUTO**.

The MODE button can also be used to select AUTO.

AIR PURIFIER

To operate only the air purifier.



Press

- Air purifier lamp lights.

To return to the previous mode, press the air purifier button again.

● AUTO

The unit maintains the humidity level by automatically controlling airflow and operating intermittently as necessary. All you have to do is set the humidity level.

- The unit turns off when current humidity decreases past the set humidity level, and restarts when the level is exceeded. (airflow and louvre stops)
- The unit operates for 6 minutes continuously regardless of the humidity level immediately after turning the power on.

Information Frequent use of exits and room size/conditions may cause the humidity to not reach the set level.

<To view set humidity level/To set humidity level>



Press

- Pressing the button once displays the set humidity level with the **SELECTION** indicator. After 3 seconds, the display returns to the current humidity display.



Press again

- Pressing the button while **SELECTION** is displayed sets the humidity level. Each time the button is pressed, the humidity setting changes.



● AIR PURIFIER

The unit cleans the air by passing it through the pre-filter and silver ion filter. The dehumidifying function is disabled.

Information

- The air passes through the silver ion filter in all modes, cleaning the air even if the air purifier lamp is not lit.
- Cigarette smoke and toxins found in smoke, such as carbon monoxide, cannot be removed with these filters.

E

Operating

Swing Louvre Function (how to read the swing monitor)

The louvre can be made to swing. Select from the 4 possible settings to suit the purpose.



- Starts swing operation.
- The swing monitor is displayed.

The swing operation stops when the power cord is unplugged.

This indicates the range of louvre swing. (The louvre and monitor do not move in synchronization.)

With each press of the button

- Stop swing operation



The swing monitor turns off.

To stop the louvre at the desired angle

To change the louvre to a desired angle, wait until the louvre stops, then adjust by hand.

- WIDE

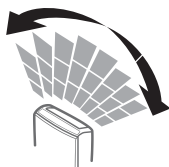

To cover the entire room

The louvre swings from the UPWARD position through to the REAR position.

- UPWARD



For drying clothes, etc.

Swing speed is automatically controlled to send air at washing from all angles.

The louvre moves slowly through the last 30° of the swing, as the time taken to traverse the rear arc is shorter than that for the upward arc when moving at a constant speed.

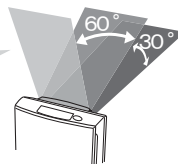

- REAR



For directing air into a closet

Using the louvre blade for downward blowing

To dehumidify blankets, carpets and tatami mats
To dry shoes

1. Pull up the louvre.

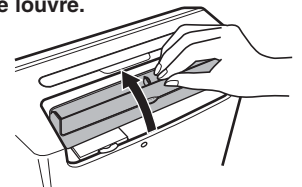

2. Pinch the louvre with fingers and open the louvre blade for downward blowing.

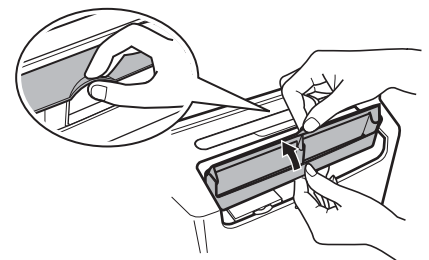

3. Push down the louvre.

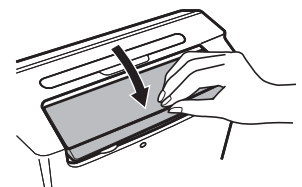

Information

- The level of noise emitted from the unit varies according to the angle of the air-flow.
- The louvre may stop up to a maximum of 8 seconds to correct its position, after which it will start moving again.
- If the louvre is knocked out of the desired angle, readjust by following the above steps.

Note

Stop the louvre in the vertical position when using the unit against a wall. Blowing air at the wall may cause staining

Drying Inside

The inside of the unit can be dried to suppress mildew growth on the cooler. On days the dehumidifier is used, drying inside is recommended.

Automatic operation

To activate drying inside after every use.

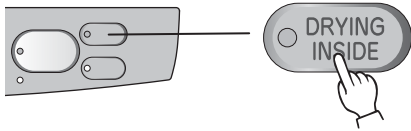

Press while the unit is on

- **Drying inside standby**
(Drying inside lamp lit)



Drying inside starts when operation ends

When the unit is turned off, INTELLIGENT LAUNDRY mode ends, or the OFF timer ends.

- **Drying inside starts**
The Drying inside lamp flashes, the humidity indicator turns off, and the louvre stops in the vertical position.

Drying inside mode

- **Drying inside ends**
The Drying inside lamp turns off and the louvres shut.

<To deactivate automatic operation>

Press the drying inside button while the unit is on (the Drying inside lamp turns off)

Manual operation

To activate drying inside by pressing a button.

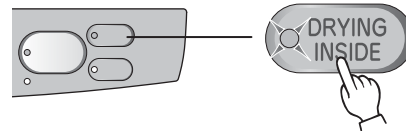

Press while the unit is off

- **Drying inside starts**
The Drying inside lamp flashes, the humidity indicator turns off, and the louvre stops in the vertical position.

Drying inside mode

- **Drying inside ends**
The Drying inside lamp turns off and the louvres shut.

To abort drying inside

Press the drying inside button while the unit is performing drying inside (the Drying inside lamp turns off)

Press the power button to abort drying inside, and resume normal operation.

Information

- Connecting/disconnecting the power plug deactivates automatic operation.
- This function does not remove existing mildew. Also, aborting drying inside may cause the benefits to diminish.
- Do not close the louvres while drying inside as this causes noise.
- The moisture expelled from inside the unit may cause the humidity level of the room to rise.
- The air leaving the unit may appear white depending on the humidity or temperature of the room.
- The moisture expelled from inside the unit may smell due to odorants* that were not caught by the filter dissolving in the water.
* The silver ion filter is mainly for absorbing ammonia.
- The OFF timer cannot be set during drying inside.

<Drying inside operation>

This operation takes approximately one hour. However, when the room temperature is below 1°C, drying time is shortened to protect the compressor.

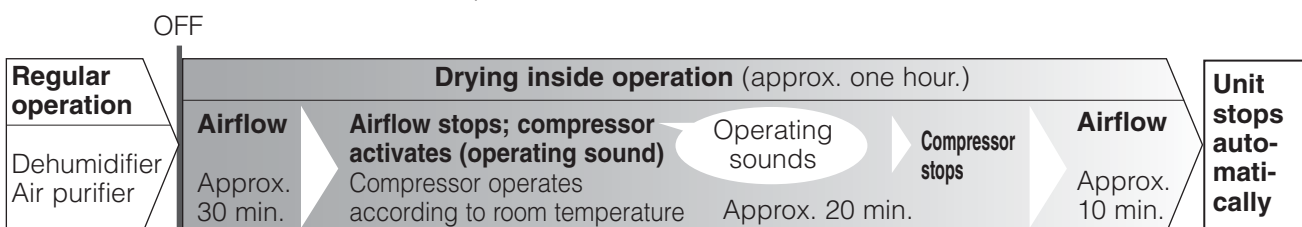

Operating



Using the Timer

OFF timer operation

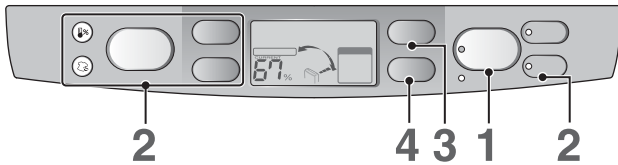
The OFF timer can be set for 1 to 9 hours. Set the timer when the power is switched on.



To set

- 1 Switch the power on.  12
- 2 Select operating mode.  13-15
Select desired operating mode.
- 3 Change the louvre swing direction.  16
Select the desired setting.
- 4 Set the operation time.



Press

- When pressed once the figure [.] and [OFF] appear.
- Each subsequent press changes the display in order from 1 to 9 hours. (Hold the button to run automatically through the numbers.)

→ No Display → 1 → 2 ... → 8 → 9

→ The OFF timer is set.

The following is an example of a display indicating AUTO dehumidifying (set to 60%), swing set to WIDE and the OFF timer set for 2 hours.

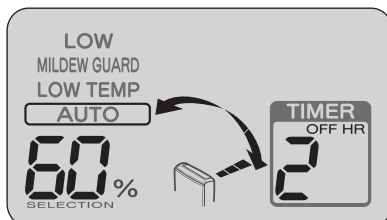

- The time remaining until the unit switches itself off is indicated in increments of one hour.
- When the set time is reached, the unit switches itself off and the louvre closes automatically.

Drying inside will commence if it has been activated.  17

To cancel

<When you want to turn the unit off>

Press the POWER button. (Power off)

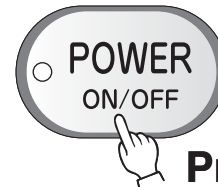

Press

- The OFF Timer is cancelled.

<When you want to disable the Timer OFF mode, and continue operation>

Keep pressed until the remaining time display disappears.



Press

- The OFF Timer is cancelled.

Information

- Empty the water tank before operating. The unit stops and the Tank full lamp lights if the tank becomes full during operation.
- The OFF timer and ON timer cannot be set at the same time.
- Do not use the timer OFF mode in conjunction with INTELLIGENT LAUNDRY or MILDEW GUARD.
- The OFF timer cannot be set during drying inside.

ON timer operation

The ON timer can be set for 1 to 9 hours.
Set the timer when the power is switched off.

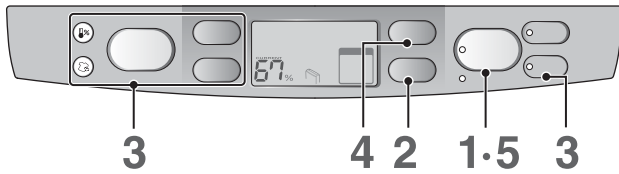

To set

- 1 Switch the power off. ¹²
- 2 Set the time you wish the unit to turn on.



Press

- Press once. The Power lamp, Mode indicator, and a [.] on the digital display flash. The [ON] indicator lights.
- Each subsequent press changes the display in order from 1 to 9 hours. (Hold the button to run automatically through the numbers.)



- 3 Select operating mode. ¹³⁻¹⁵

Select desired operating mode.
Set drying inside as desired.

- 4 Change the louvre swing direction. ¹⁶

Select the desired setting.

- 5 Confirm the operating start time.

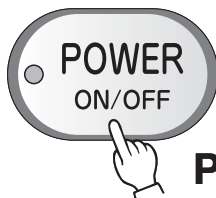

Press

- Power lamp and Timer display light.
→ The ON timer is set.

The unit informs you if you forget to press the Power button by making the Timer display and Mode indicator blink and sounding an alarm for 1 minute.

The following is an example of a display indicating AUTO dehumidifying (set to 60%), swing set to WIDE and the ON timer set for 5 hours.

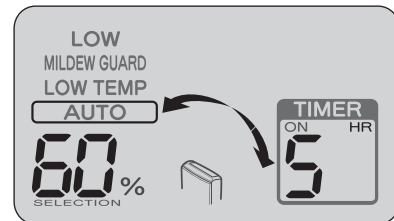

- The time remaining until the unit switches itself on is indicated in increments of one hour.
- When the set time is reached, the unit switches itself on.

To cancel

Press the Power button.

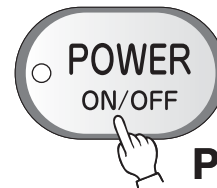

Press

- The ON timer is cancelled.

Information

- Drying inside is deactivated when the ON timer is set during drying inside operation.
- The ON timer function is not operable using a commercially-available timer plug outlet.

E

Operating

Using the Child Lock

To lock

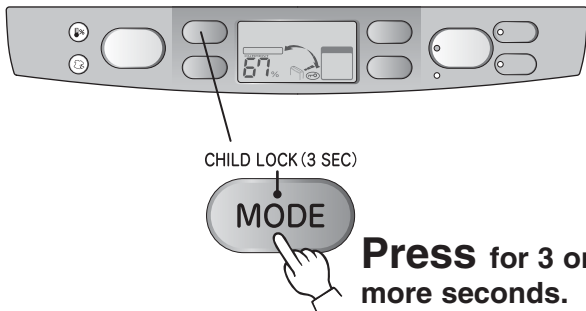

● The child lock indicator

The child lock is switched off when the power cord is unplugged.

When the child lock is activated, the other buttons are inoperable. Deactivate the child lock to use the other buttons.

If you lock the unit when the POWER is OFF.

The unit will not turn on, even if you press the POWER button to turn it on. Only the CHILD LOCK lamp will blink.

(Press the POWER button once again so that the lamp lights.)

If you lock the unit when the POWER is ON.

The unit will not turn off, even if you press the POWER button to turn it off. Only the CHILD LOCK lamp will blink.

(Press the POWER button once again so that the lamp lights.)

Releasing the child lock

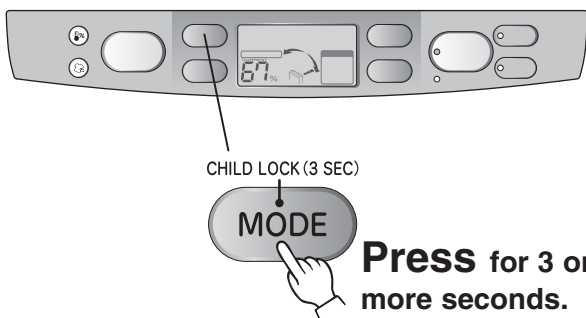

● The child lock lamp goes out.

Carrying the Unit

Pull the handle out, and grasp with a firm grip

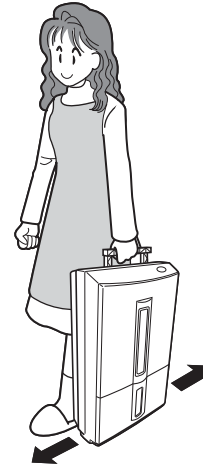

Use the wheels as shown above when moving the unit.

Before moving the unit, first make sure to remove water from the water tank and close the louvre. The unit only moves on one axis. The unit may topple over if it is moved forcefully in another direction.

Note

- Do not carry the unit on its side as this may cause malfunctions.
- Wheel the unit on a hard, flat surface.
- Lift the unit over steps or up stairs. Avoid using the wheels on thick carpet as this may damage the carpet.
- Do not let the power cord drag, as this may damage the cord.

Removing Water from the Tank

The unit automatically shuts down and lights the Tank full lamp when the tank (approximately 3.8 L) is full. Empty the tank.

1 Remove the water tank.

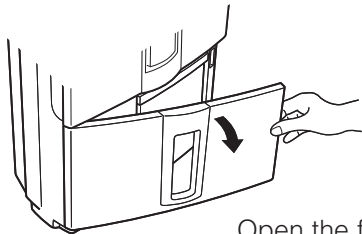

Open the front door.

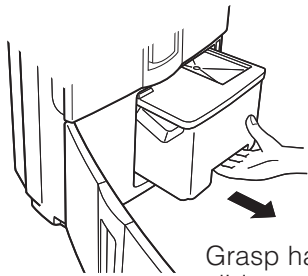

Grasp handle and slide out.

<Hold the tank this way>

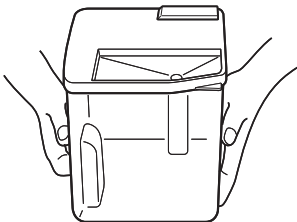

2 Remove the tank lid, and empty.

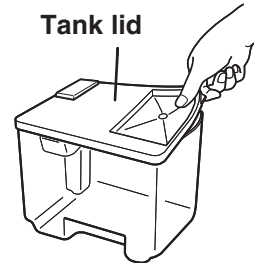

Tank lid

Floating element

Do not remove or dismantle the float.

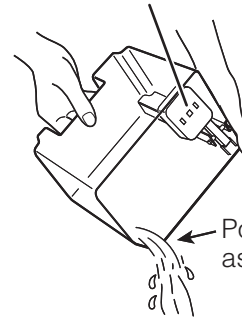

Pour the water out as shown.

3 Reattach the tank lid and replace the water tank.

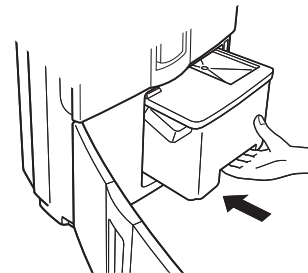

Confirm that the lid is securely attached to the water tank, and push the tank in. Close the front door.

- If the lid is not properly closed, you may have problems removing the tank.
- If the tank is not installed correctly, the tank full lamp will come on, and the unit will not operate.

Note

Do not remove or dismantle the floating element in the tank. If it is removed, the unit cannot detect when the tank is full, and this could result in leakage.

E

Operating

Continuous Drainage

If a drain is available, the unit can continuously drain excess water by attaching a commercially available hose (internal diameter 15 mm). The unit can be operated for extensive periods without the need to empty the water tank.

Necessary items

- **Commercially available hose (ID 15 mm)**
Long enough to reach the drain.
- **Side Cutters**

How to set up the drainage hose

Correctly installed



Incorrectly installed

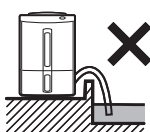

- Hose immersed in water.
 - Hose raised to a level higher than the drainage outlet.
- **The water will not drain.**

1 Remove the water tank.

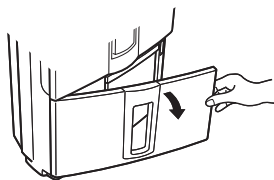

Open the front door.

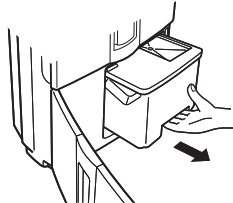

Grasp handle and pull out.

2 Open the drainage outlet.

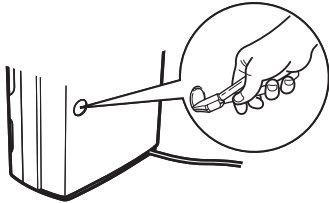

Use cutters to cut the three fixing ribs of the continuous drainage port on the back of the main unit, then remove it carefully making sure that it does not fall inside the unit.

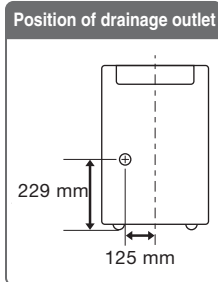

3 Press drain stopper.

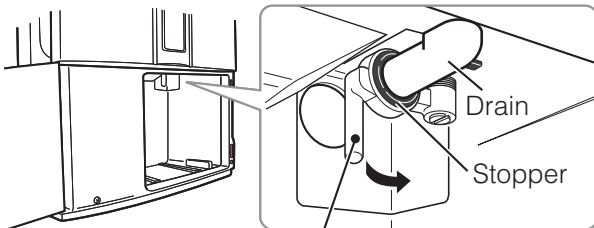

Push here

4 Insert the hose into the drainage outlet on the back.

- ① Feed the commercially available hose (ID 15 mm) into the drainage outlet while keeping the stopper pressed.

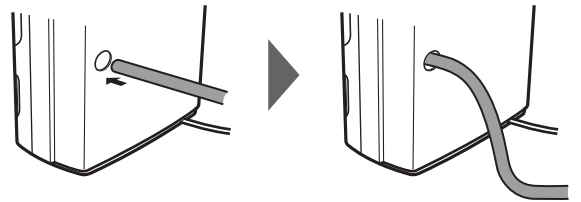

- ② Feed the hose into the drainage outlet.

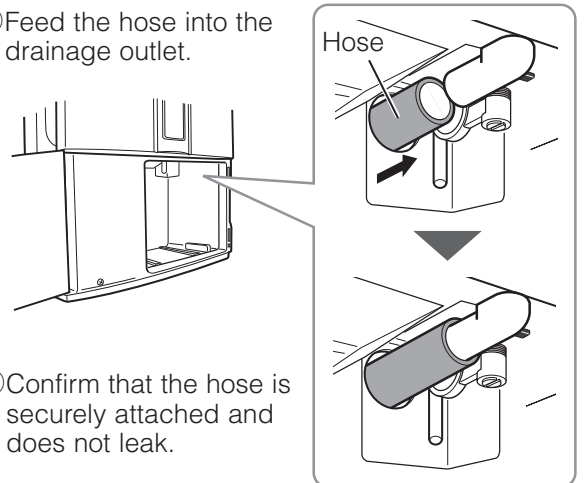

- ③ Confirm that the hose is securely attached and does not leak.

5 Replace the tank, and set the end of the hose in the drain.

The unit cannot operate without returning the tank.



CAUTION



Do not drain water continuously if there is a possibility that temperatures around the hose could drop below freezing point.

Water inside the hose may freeze and water may leak from the unit and **damage surrounding objects.**



When draining water continuously or left unattended for long periods, inspect the unit once a fortnight.

Foreign objects, etc. could clog the hose **resulting in overheating and/or leakage.**

Note

- Leave a minimum space of 20 cm behind the unit for attaching the hose.
- Confirm that the hose does not show signs of deterioration such as cracks and clogging.
- Inspect the hose every 2 weeks. Insects or dirt blocking the hose may cause leakage resulting in malfunctions.

Maintenance

Do not use detergents, cleaning agents for heat exchange equipment, abrasive powders, chemically treated dusters, gasoline, benzene, thinners or other solvents, as they can damage the unit or the water tank, which may result in leakage.

Cleaning

Water tank • Main unit

Wipe with a soft cloth.

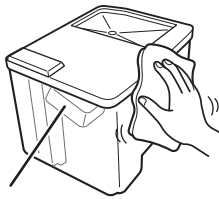

Floating element
Do not remove or dismantle.

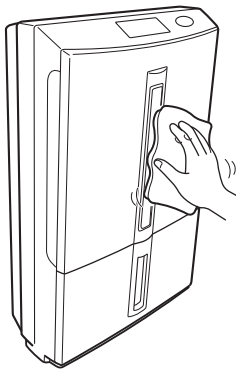

- The unit draws in dust present in the air, and this may cause the tank to **gradually become dirty**. If the dirt does not come off easily, wash with cold or warm water, then wipe with a soft, dry cloth.
- Mildew may form in the tank unless kept clean.

Once every two weeks

Pre-filter

Debris clogging the pre-filter reduces the effectiveness of the dehumidifier. Clean once every 2 weeks.

For maintenance procedures see 

- 1 Remove the front panel and pre-filter.**
- 2 Remove the silver ion filter.**
- 3 Clean the pre-filter.**

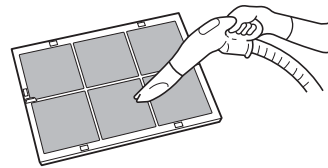

Remove grit with vacuum cleaner

- 4 Fit the silver ion filter.**
- 5 Attach the pre-filter and front panel.**

E

Operating

Troubleshooting

Once every three months

Silver ion filter

Soak the filter in water about once every three months.
For maintenance procedures see  10

1 Remove the front panel and pre-filter.

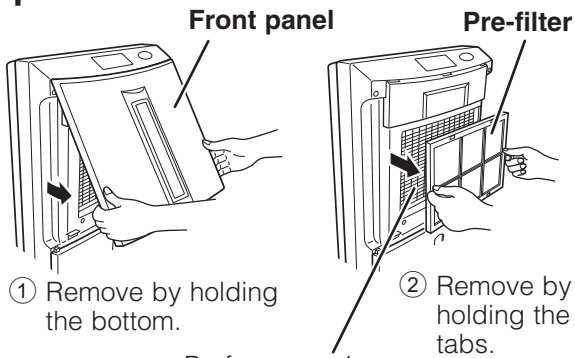

Performance is unaffected even if the metal fins inside the main unit are slightly bent.

2 Remove the silver ion filter.

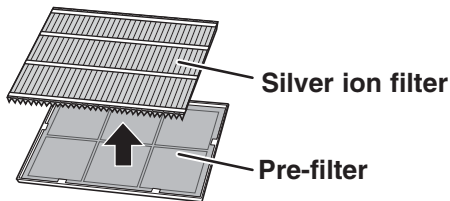

3 Soak the silver ion filter in water.

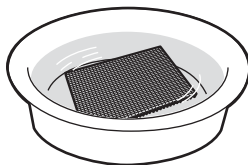

Soak in cool to lukewarm water for 30 minutes.

Do not use detergent or hot water. Also, do not brush or rub while soaking as this may damage the filter.

- Stains may remain on the filter, but should not affect performance.
- The filter can be soaked for a total of eight times.
After that, replace with a new filter.

4 Dry the silver ion filter.

Do not hang with pegs as this may damage the filter.
Do not use the filter while wet.

5 Fit the silver ion filter.

With the strips facing up, set the silver ion filter inside the tabs on the pre-filter.

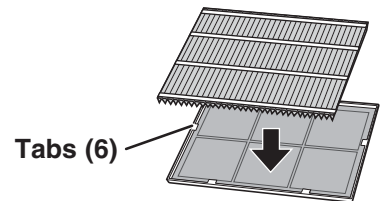

6 Attach the pre-filter and front panel.

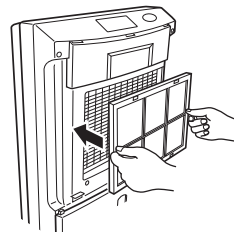

① Attach by holding the tabs.

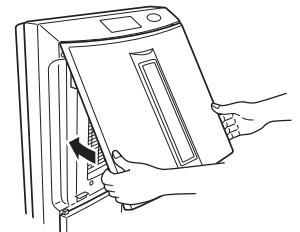

② Hook the top edge to the top part of the unit and push the bottom in.

Replacing Consumable Parts

The silver ion filter and supplement cartridge become depleted over time.

Replace them when necessary. The dehumidifier can still operate without replacing the supplement cartridge. Replace as desired.

Replacing the silver ion filter

Although the silver ion filter lasts roughly 2 years, replace it when:

- You have soaked the filter 8 times.
- The silver ion filter has turned brown due to cigarette smoke or black with dust.

Life of the silver ion filter differs on usage and environmental conditions.

Remove the front panel and pre-filter to replace the silver ion filter.

For maintenance procedures see  10

Replacing the supplement cartridge

Replace after 6 months.

Detach the case from the unit and replace the cartridge. Only replace the cartridge. Do not throw away the case.

For maintenance procedures see  11

Parts sold separately

Silver ion filter for replacement

- Type: MJPR-ECGFT
- Type code: 5C7 859

Supplement cartridge for replacement

- Type: MJ-E100SPL
(This contains the same content as KD-E100SPL.)
- Type code: 5C7 810

For these items contact your nearest Mitsubishi Electric dealer.

Storage and Disposal

Storage

After switching the unit off, leave for one day until any water inside has had time to run off, then carry out the following steps.

1 Perform drying inside. 17

Performing drying inside to prevent mildew growth is recommended.

2 Bundle power cord.

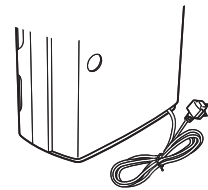

3 Remove the drainage water. 21

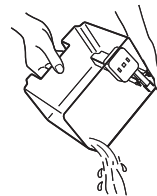

Empty the water tank and wipe away any remaining drops of water.

4 Clean the pre-filter. 23

Remove grit with vacuum cleaner

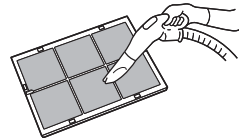

5 Store the unit.

- When you are sure that all parts of the unit are dry, cover it with a cloth to keep it from dust.
- Store the unit in an upright position in a place not exposed to direct sunlight.

When disposing the unit

Dispose according to the garbage regulations in your district.

















- Silver ion filter
Material: PET and PS
- Supplement cartridge
Material: PP
Do not disassemble. Dispose as plastic waste.
- Unit
Do not disassemble. Dispose according to the garbage regulations in your district.

W

Troubleshooting

Troubleshooting

● For the symptoms listed below, refer to the remedies listed right.

Symptom	Cause/Remedy
The unit blows warm air	<ul style="list-style-type: none"> Dehumidified air passes through heating coils causing it to warm (this unit is not a cooler). This is not a malfunction.  10
Water does not collect in the water tank (minimal dehumidifying results)	<ul style="list-style-type: none"> Check to see if the temperature/humidity is low. Low room temperature/humidity reduces dehumidifying effectiveness. Confirm the current humidity reading (in winter, the air is cooler reducing the amount of water collected). This is not a malfunction.  3
The unit does not turn on (no air comes out) The unit keeps turning off	<ul style="list-style-type: none"> Check to see if the power cord is correctly plugged. → Plug the power cord properly into the power socket.  11 Check to see if anything is blocking the air intake or outlet. → Remove the obstruction.  5 Check to see if the pre-filter is clogged. → Clean according to the maintenance procedures.  23
	<ul style="list-style-type: none"> Stops after a short time <ul style="list-style-type: none"> Check to see if the unit is operating in "INTELLIGENT LAUNDRY" mode. The unit may sometimes stop operation after just a short amount of time as a result of conditions such as the room temperature and humidity.  13
	<ul style="list-style-type: none"> Louvre does not swing <ul style="list-style-type: none"> Check to see if the unit is in EASY DEHUMIDIFYING, MILDEW GUARD, or AUTO. The unit is automatically controlling the dehumidifier, fan, and standby times.  13-15
	<ul style="list-style-type: none">  FULL lights <ul style="list-style-type: none"> Check to see if the water tank is full. → Empty the water tank and return it to its original position.  12-21 Check to see if the water tank is inserted properly. → Adjust the position of the water tank.  11
	<ul style="list-style-type: none">  indicates <ul style="list-style-type: none"> Check to see if the unit is in defrosting mode. The unit activates defrosting mode when the room temperature drops below 15°C. The dehumidifier and blower functions stop during defrosting.  9
The unit continues to operate even though it is turned off	<ul style="list-style-type: none"> Is the unit set to drying inside mode? This function activates automatically after the unit finishes operating.  17
The humidity level does not reach the level set	<ul style="list-style-type: none"> Check to see if the room is not too large. Check to see if the exits to the room are open. → Refrain from opening doors/windows during operation. Check to see if steam producing appliances such as kerosene heaters are on in the vicinity.
The hygrometer reading on the unit differs from other hygrometers in the room	<ul style="list-style-type: none"> Hygrometer readings differ from place to place even if in the same room. Use the unit humidity reading as an estimate.  10
The louvre does not move as set	<ul style="list-style-type: none"> Press the Swing louvre button again.  16
The water tank contains liquid or white water residue	<ul style="list-style-type: none"> The residue is from final product testing at the factory. It is not a result of a malfunction.
There is black residue on the inside of the water tank and lid	<ul style="list-style-type: none"> The residue is from debris in the air. → Clean according to the maintenance procedures.  23

Symptom		Cause/Remedy
The unit makes noises	The operating noise is loud/reverberates	<ul style="list-style-type: none"> ● Check to see if the unit is on a slope or uneven surface. → Move to a sturdy even surface. 5 ● Check to see if the pre-filter is clogged. → Clean according to the maintenance procedures. 23 ● Operating the unit in small rooms or in tight spaces sometimes causes the sound to reverberate. → Place a mat underneath the unit. 6
	The operating sound suddenly increases in volume	<ul style="list-style-type: none"> ● The sound increases when the compressor activates (3 minutes after turning on the unit or during One-touch dehumidifier and Automatic modes).
	The wind sound changes in volume	<ul style="list-style-type: none"> ● The volume of the sound differs depending on the angle of the louvre. 16
	The unit produces a simmering sound	<ul style="list-style-type: none"> ● This is the sound of the refrigerant. The sound can be heard while the refrigerant stabilises after the unit turns on, changes modes, or stops.
	The unit produces a buzz that sounds intermittently (or the compressor does not activate)	<ul style="list-style-type: none"> ● This is the sound of the compressor. In modes that monitor the humidity level or during drying inside, the compressor operates intermittently causing the sound to be heard occasionally. The compressor does not activate after turning the unit off, or for 3 minutes after plugging the unit into a power socket. (This is to protect the compressor from damage.) 12
The unit produces an odour	When first used	<ul style="list-style-type: none"> ● The heat converter heats rapidly causing a brief odour. This is not a malfunction.
	During drying inside	<ul style="list-style-type: none"> ● The moisture expelled from inside the unit may smell due to odorants that were not caught by the silver ion filter dissolving in the water. This is not a malfunction.

● **Error message (Humidity indicator)**

Digital display	Cause/Remedy
<i>A2</i> or <i>A3</i> is displayed	<ul style="list-style-type: none"> ● Check to see if the power cord is plugged into the power socket properly. → Plug the power cord into the power socket properly. 11
<i>P4</i> is displayed	<ul style="list-style-type: none"> ● Check to see if anything is blocking the air outlet. → Remove the obstruction, and plug the power cord into the power socket again. 5-11 ● Check to see if the pre-filter is clogged. → Clean according to the maintenance procedures. 23
<i>A1</i> , <i>A6</i> , or <i>E0</i> through <i>E8</i> is displayed	<ul style="list-style-type: none"> ● Malfunction → Take note of the error message, unplug the power cord, and seek service assistance using the number on the next page.

- If the symptoms persist even after following the prescribed remedies, or the error message does not disappear, unplug the power cord, and seek service assistance using the number on the next page.
- If the supply cord is damaged, it must be replaced by the manufacturer, its services agent or similar qualified persons in order to avoid a hazard.

Specifications

Model		MJ-E82GH-H	
Power supply		Single phase 220 V, 50 Hz	
Condition	Temperature	26.7°C	30°C
	Relative humidity	60%	80%
Dehumidifying capacity*¹		8.2 L/day	14.0 L/day
Power consumption		210 W	240 W
Recommended room size*²	LOW*³	34 m²	
	EASY	23 m²	
Water tank capacity		Stops automatically at approx. 3.8 L	
Weight		11.7 kg	
Dimensions (h × w × d)		589 mm × 384 mm × 187 mm	

*¹ The dehumidifying capacity indicates the amount of dehumidification per day (24 hours).

*² House condition: Concrete house

*³ Dehumidifying area: According to standards of JEMA

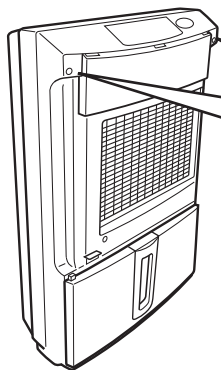

NOTE

It is impossible to remove the back panel because the two spots shown are fastened with two special screws. If the unit malfunctions, contact your Mitsubishi dealer.

Sole Agent in Hong Kong

Mitsubishi Electric Ryoden Air-Conditioning & Visual Information Systems (Hong Kong) Limited.

Head Office: Tel.: 2510 1505 Service Center: Tel.: 2427 8484

Fill in the following for your future reference.

Place of purchase:	Telephone number:		
Authorised Service Centre:	Telephone number:		
Date of purchase:	Day	Month	Year

MITSUBISHI ELECTRIC CORPORATION