

DEHUMIDIFIER

MODEL

MJ-EV240HP-H

INSTRUCTION MANUAL

English

E

Features

- Compact and powerful
- Eco Auto, energy saving
- Air purifying function with PM2.5 filter

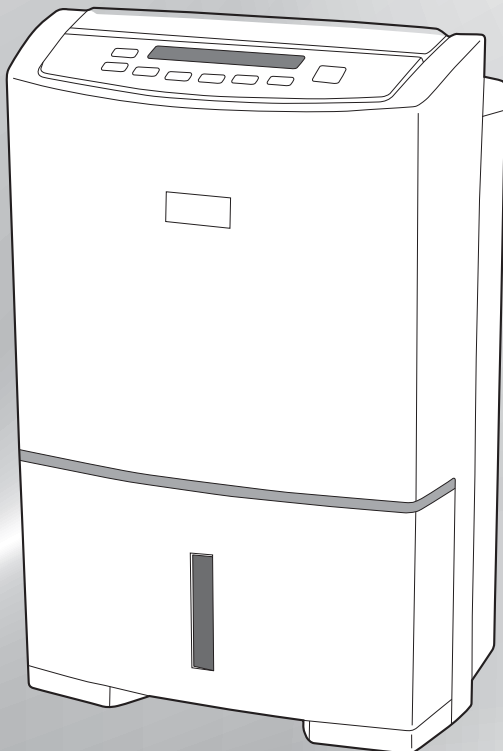

Table of Contents

● Recommended Ways of Using the Unit	2	Before Using the Unit
● Precautions	3	
● Warning	5	
● Tips on Dehumidification	5	
● Features of This Dehumidifier	6	
● Names and Functions of Parts	7	
Front/Back	7	
Control Panel/Inverter Indicator/LCD Display	8	
● Before Using Your Dehumidifier	9	
● Carrying the Unit	9	
● Drying Laundry	10	Operating
INTELLIGENT LAUNDRY		
● Dehumidifying	12	
ECO AUTO/EASY/HIGH/LOW/MILDEW GUARD		
● Cleaning the Air (AIR PURIFIER)	15	
● Replacement Parts	15	
● Using Child Lock	15	
● Using Louvre	16	
● Using Timer	17	
OFF TIMER/ON TIMER/		
● Drying Inside Operation	18	
● Draining	19	
● Continuous Drainage	20	
● Maintenance	21	Troubleshooting
● Storage	21	
● Troubleshooting	22	
● Specifications	24	
● Disposal	24	

This appliance is designed for use in Hong Kong and Macau only and please do not use in any other countries.

Recommended Ways of Using the Unit

When you want to dry laundry

When you want to perform automatic operation

● **INTELLIGENT LAUNDRY**

▶ P.10

When you want to perform continuous operation

● **HIGH**

▶ P.12-13

Tips on Drying Laundry
P.11



When you want to dehumidify ▶ P.12-13

When you want to set the humidity

● **ECO AUTO**

When you want to perform automatic operation

● **EASY**

When you want to perform continuous operation

● **HIGH**

Reducing blowing sound and performing continuous operation

● **LOW**



When you are worried about mildew in the bathroom

● **MILDEW GUARD**

▶ P.12-14



When you want to clean the air

● **AIR PURIFIER**

▶ P.15

Precautions

The following diagrams indicate circumstances where danger can result from mishandling the unit.



WARNING

Mishandling may result in fatal or serious injuries.



CAUTION

Mishandling may result in minor injuries or damage to your home or property, etc.



Forbidden



Do not disassemble



Keep away from fire



Do not subject to water



Always follow the instructions



WARNING

Do not damage or modify the power cord or plug. Do not use power sockets in which the plug fits loosely.

Do not modify, bundle, twist, bend or heat the power cord. Do not place under objects or use with the end close to the plug bent. (Keep pets from biting the cord.)

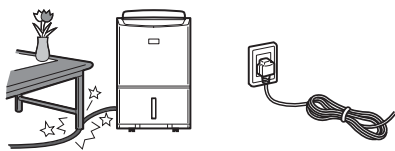

The cord may be damaged **resulting in fire, electric shock or heat generation.**

Do not plug many power cords into one power socket.

This may **result in fire or electric shock.**



Do not start/stop the unit by plugging/unplugging the power cord.

This may **result in fire and/or electric shock.**



Do not put the unit near heat-generating devices (such as stoves, fan heaters, etc.).

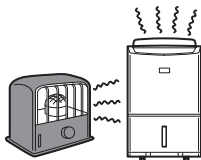

The plastic parts may melt and **cause fire.**

Do not put your fingers or any long object, into the air intake/outlet. Do not touch the swing louvre.



The internal fan rotates at high speeds, and such actions may **result in injury.**

Do not attempt to repair, disassemble, or modify the unit.

This may **result in fire and/or electric shock.** Refer servicing to your dealer or Mitsubishi Electric Service Centre.



- This appliance is not intended for users (including children) with insufficient physiological, sensory or mental capabilities or the lack of experience or knowledge, unless it is used under the supervision or instruction of a qualified safety personnel.



- Children should be supervised to ensure that they do not play with the appliance.

Exclusively use 220 V AC power sockets for the power supply.

Failing to do so may **result in a fire and/or electric shock.**

* Use an extension cord by itself.



Wipe dust off the power plug and insert the plug firmly.

If the plug is not fully inserted into the socket, dust may gather on the connectors which may **cause fire and/or electric shock.**



Should abnormal symptoms occur (a burning smell, etc.), switch off the unit and unplug it from the socket.

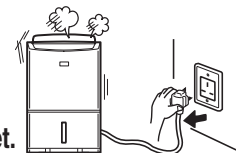

Continuing to operate the unit may **result in fire or electric shock.**

Contact your dealer or Mitsubishi Electric Service Centre for consultation.

Remove water that has collected in the tank.

Accidentally drinking the water or using it for other purposes may **cause illness and/or unforeseen accidents.**



⚠ CAUTION

Do not cover an air outlet or air intake with laundry, cloth, curtain, etc.

This results in poor ventilation and may **cause heat generation/fire**.

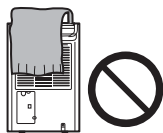

Do not put vases or any other objects filled with water on the unit.

Water may leak into the unit adversely affecting electric insulation and **cause electric shock and/or fire** by short-circuiting.



Do not use the unit in a bathroom or other location where it is likely to come into contact with water, or wash it with water.



Exposure to water may **result in fire or electric shock** caused by an electric leak.

Do not use the unit where it may be exposed to direct sunlight or other weather conditions.

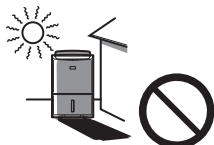

(This unit is for indoor use only.)

This may **cause overheating, electric shock and/or fire** caused by an electric leak.

Do not use the unit in narrow, enclosed places such as inside closets, between pieces of furniture, etc.



This results in poor ventilation and may **cause heat generation and/or fire**.

Do not use combustion appliances in the path of the air outlet.

This may **cause incomplete combustion** in the appliance.

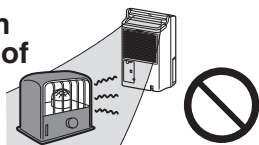

Do not use the unit in places that may be subject to oil or flammable gas leakage.

Such a leak around the unit may **cause combustion and fire**.



In addition, chemicals and solvents evaporated in the air may deteriorate the unit (crack the main body) and cause water in the tank to leak, **resulting in damage to property**.

Do not use the unit in places where chemicals are used (such as hospitals, factories, laboratories or beauty salons).

Chemicals and solvents evaporated in the air may harm the unit and cause water in the tank to leak, **resulting in damage to property**.



Do not use the unit for special purposes, such as preservation of food, art or scientific works.

This may **negatively affect the quality** of the items stored.



Do not point airflow from the unit directly at the body for a prolonged period of time.

Be especially careful when using the unit where there is someone who is unable to adjust the humidity (infant, child, or elderly person).

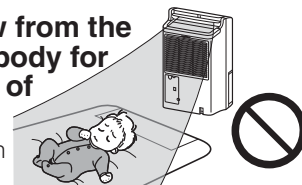

If air-flow is directed at the body for long periods, it may **harm one's physical condition and lead to dehydration**.

Do not stand on, sit on or lean against the unit.

As the unit is on casters, it may move, tip over, or fall **causing personal injury**.



Do not remove the Styrofoam from the floating element.

The floating element will not be able to detect a full tank resulting in water leakage, **which may damage surrounding objects or cause electric shock and/or an electric leak**.

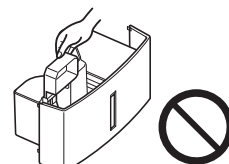

Do not drain water continuously if there is a possibility that temperature around the hose could drop to freezing point.

Water inside the hose may freeze and prevent the water in the tank from flowing out. The water may leak from the unit and **damage surrounding objects**.



Install the unit in a location where the floor is flat and stable.

If the unit falls over, the water collected in the water tank may leak **damaging surrounding objects and in turn result in fire or electric shock caused by an electrical leak**.



Before moving the unit always switch it off, unplug it and remove water from the water tank.

Moving the unit with water in its tank may cause the water to leak and **damage the surrounding objects and in turn result in electric shock and/or an electric leak**.



After emptying the tank, transport the unit by grasping the handle firmly.

Losing your footing while carrying the unit may **cause personal injury or damage to the floor**.



Precautions (Cont.)

CAUTION

Grasp the plug and remove from the power socket.

When removing the plug from the power socket, do not pull on it diagonally or by the cord as this may cause the projections/wiring to be damaged **resulting in a short circuit, electric shock or fire.**



Switch the unit off and unplug from the power source when cleaning it.

When the unit is on, the internal fan rotates at high speeds and may **cause injury.**

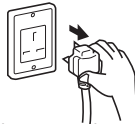

Unplug the unit from the power source when not using the unit for an extended period of time.

Otherwise it may **cause fire and/or electric shock** caused by an electric leak.



When draining water continuously or left unattended for long periods, inspect the unit every two weeks.

When the filter or hose is clogged with foreign materials or dirt, the dehumidification operation is disabled and may **cause leakage.**



When using the continuous drainage outlet, make sure to position the hose so that the water drains without obstruction.

The water in the tank may leak and **damage surrounding objects.**



Use the unit with caution in rooms where the walls, furniture and art work are vulnerable to dry air, as it may cause cracks and warping.



Warning

● Keep the unit always in an upright position.

Inclining the unit may cause water in the tank to leak into the unit, **resulting in malfunction.** Should you incline the unit accidentally, contact the place of purchase for advice.

● Do not carry or store the unit horizontally.

This may **result in malfunctions.** Such malfunctions are NOT covered under warranty.

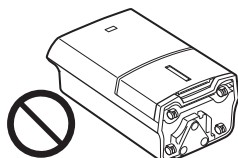

Tips on Dehumidification

Drain the water tank before use.

Close the door and windows during operation.

Drying laundry

- Remove water from the laundry.
- Pull to remove any wrinkles on the laundry.
- Use swinging louvre to blow air to the laundry.
- Keep enough space between the laundry to allow air to pass through.

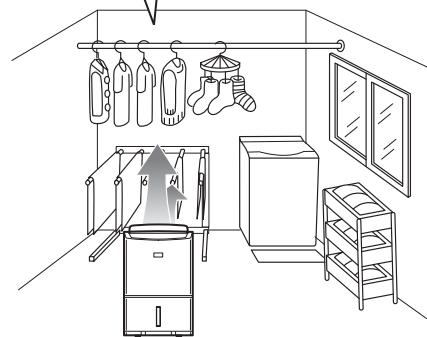

Use the dehumidifier in a small enclosed room.

In winter, drying becomes easier if you also use a heater to raise the room temperature to approximately 16°C or more.

- Drying times will vary depending on the type of the laundry and the room temperature. The low temperature may double the drying time of normal temperature. (Low temperature means approx. 10°C while normal temperature means above 20°C.)
- The strong airflow is blown from the top right point of the unit.

Installing your dehumidifier

Make sure to leave some space around the unit to ensure good results.

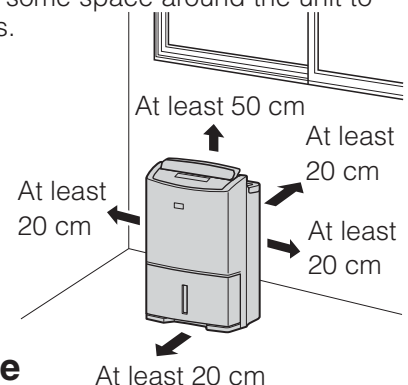

Operating noise

Place the unit on top of a mat. This reduces vibration and noise. It also prevents leaving depressions on carpets.

Features of This Dehumidifier

● Room temperature may rise 2–6°C during operation.

The dehumidifier does not have a cooler function. Due to heat produced during operation, the room temperature may rise 2–6°C. As a result, the unit may blow warm air, but this is not due to a malfunction. (During winter, the air may not feel warm as the temperature is below body temperature.)

How does the dehumidifier work?

If you pour cold water into a cup, the air around it becomes cold, causing water droplets to form on the surface of the cup.

The dehumidifier takes advantage of this phenomenon to remove moisture from the air.

- ① The unit draws air from the room, cools it with its cooling coil, causing the moisture to transform into water droplets.
- ② The water droplets fall into the water tank.
- ③ **Dehumidified air is heated by the re-heating coil, and then blown out.**

The humidity of the room is thus reduced by repeating the above steps.

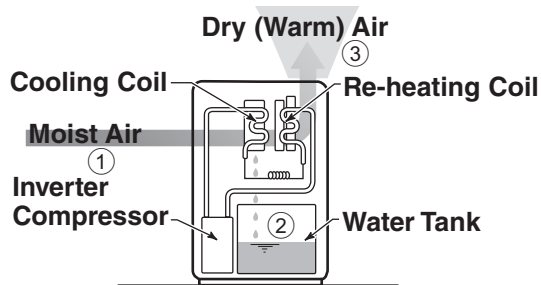

● Inverter

The inverter is a device that controls the rotational speed of the compressor motor. When an operation starts immediately or in other situations, strong dehumidification is performed at a high motor speed. When the humidity becomes stable, the motor speed is decreased to continue the operation economically.

● The unit can operate in a room temperature range of 5–35°C.

However, if the room temperature exceeds 35°C, the unit may operate in blower mode or increase the airflow. This is because the temperature within the unit rises causing the protection mechanism to operate. In order to lower the internal temperature of the unit, use the unit with the swing stopped and louvre vertical.

- If the temperature is below 5°C, only the blower is operational to prevent the extracted water freeze.

● The humidity reading on the unit may differ from a hygrometer in the same room.

Even in the same room, temperature and humidity levels may differ from place to place. If the hygrometer and the unit are in different parts of the room, the humidity levels are prone to differ. Moreover, humidity levels differ between places that have good and no airflow.

Use the reading on the unit as an estimate.

<Cause>

1. Inconsistencies in temperature and humidity
2. Difference in location
3. Difference in hygrometer precision

● The amount of dehumidifying becomes less in winter.

When the temperature and humidity are low, the amount of water collected is decreased.

In winter, because the temperature is lower than in summer, the effect of the dehumidifier is greatly reduced as shown in the graph below. Although only a little water collects in the tank, this is not a malfunction.

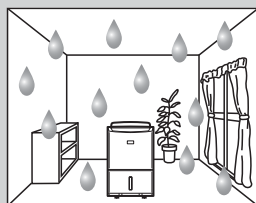

Summer (humidity)

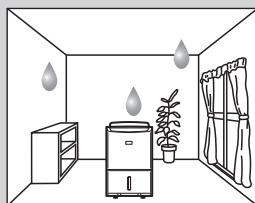

Winter (dampness)

Value for HIGH when humidity is 60%

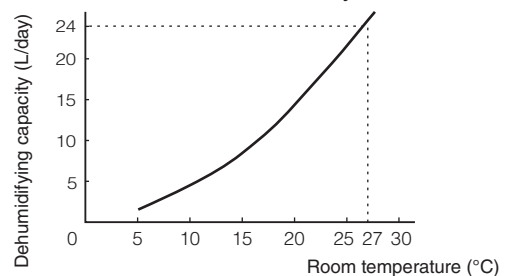

- The values shown on the graph were measured at constant temperature and humidity and do not reflect values obtained in actual usage conditions.
- The amount of dehumidifying varies depending on the operation mode.

● Defrosting operation

When the room temperature drops to about 15°C, an automatic defrosting operation starts inside the unit. During the defrosting operation, the compressor stops airflow up to once every 70 minutes to defrost the unit.

Names and Functions of Parts

Front

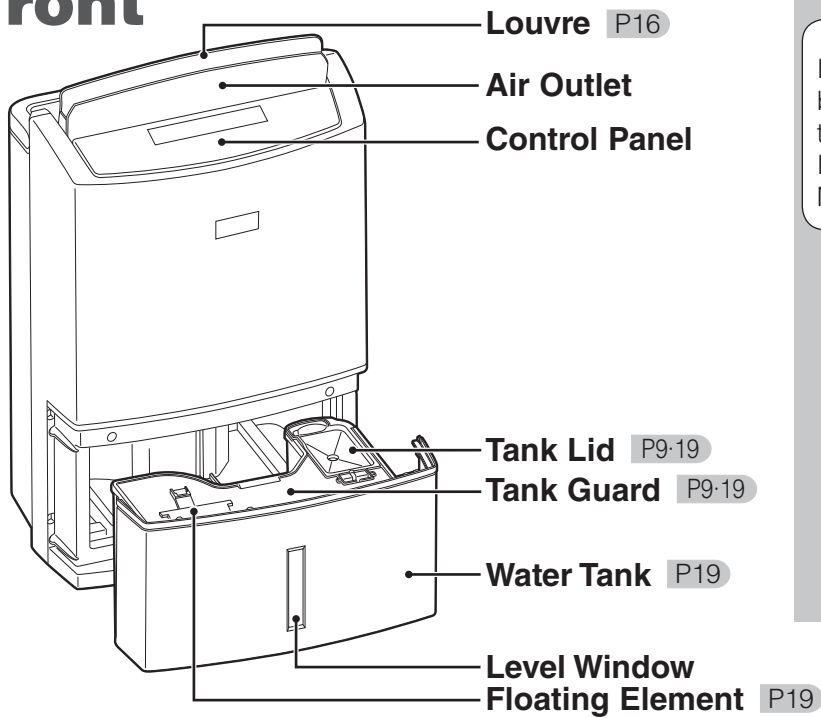

NOTE

It is impossible to remove the back panel because the four places shown are tightened with four special screws. If the unit has any malfunctions, contact the Mitsubishi Electric Service Centre.

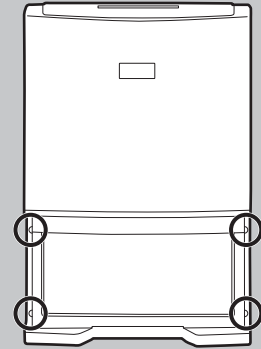

The water tank may contain water residue at time of purchase. This is from final product testing at the factory and is not due to a defect.

Back

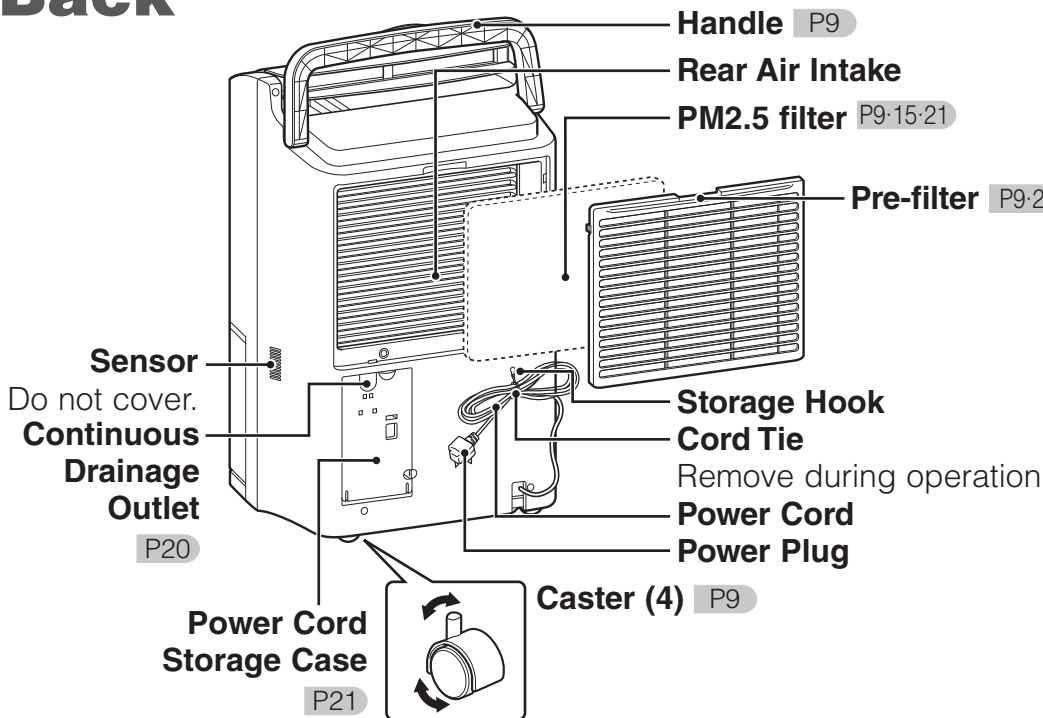

What is the PM2.5 filter?

The PM2.5 filter has a two-layer structure consisting of a white dust filter and a blue deodorizing filter.

The fine mesh filter can catch PM2.5 and dust. The fibres contain a special deodorant and anti-bacterial agent (antiallergen, anti bacterial and degerming).

This filter cannot remove cigarette smoke and poisonous gases in smoke (e.g. carbon monoxide).

Accessory

● PM2.5 filter

PM2.5 filter is supplied with the appliance at the time of purchase.

Please install it before using the appliance. P9

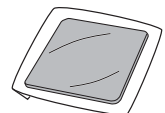

PM2.5 filter for replacement P15

Names and Functions of Parts (Cont.)

Control Panel

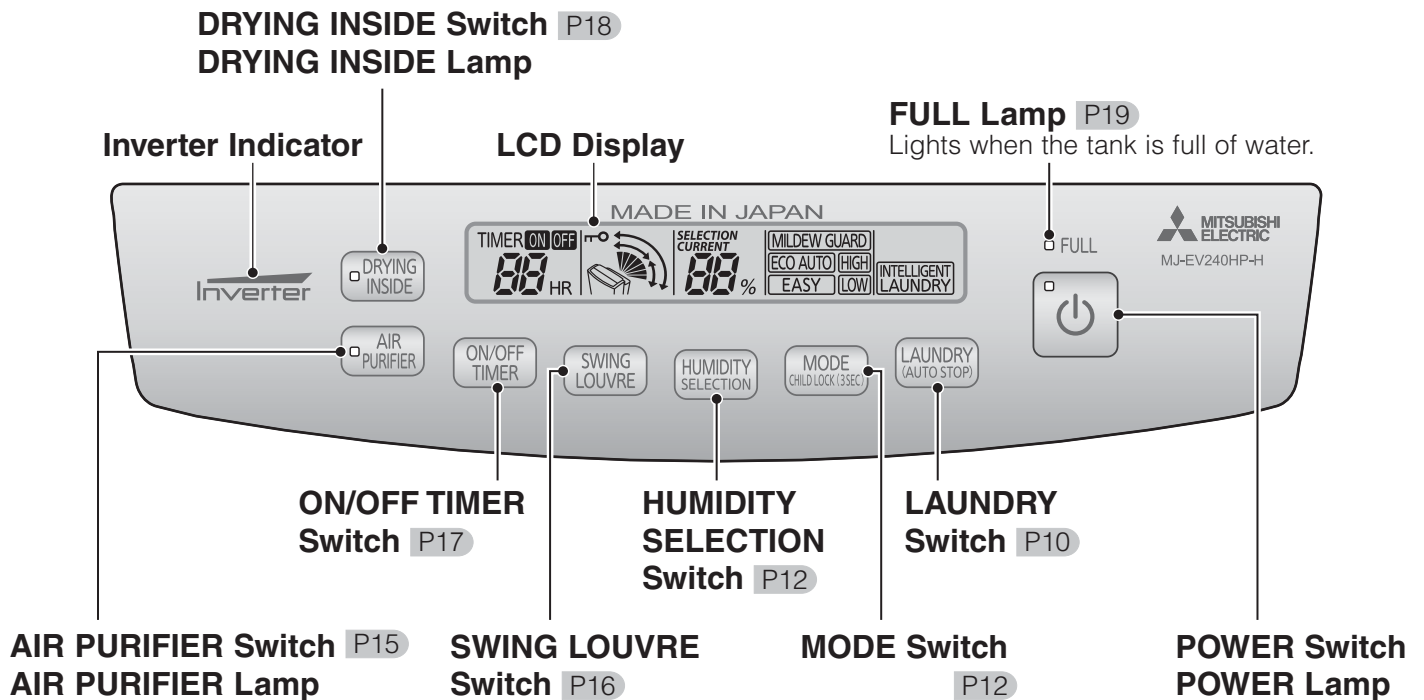

Note

- This dehumidifier remembers the operation mode. Even if the power plug is disconnected or the operation turned off, the dehumidifier will start operation with the same settings as the previous time.
- In the case of a power outage during operation, the dehumidifier will restart operation upon restoration in the operation mode before the power outage.

Inverter Indicator

Indicates the operation level of the selected operation mode.



Power-saving operation

High-power operation

- This indicator does not light during AIR PURIFIER operation and DRYING INSIDE operation, when the water tank becomes full, and when an error occurs.

LCD Display

- All of the indicators on the LCD display are shown for explanation purposes.
- If any of the switches are pressed, the backlight will turn on for 10 seconds.

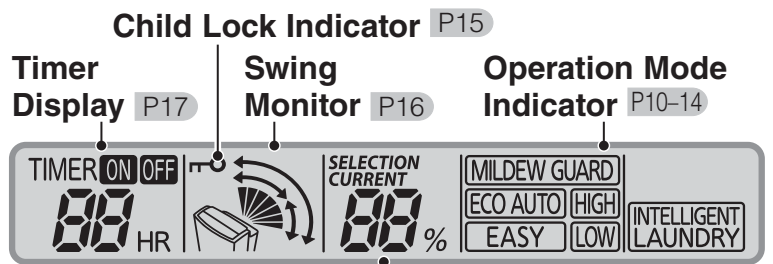

Humidity Indicator

- Indicates the approximate humidity.
- Insert the power plug into the power socket to display the current humidity.
- **CURRENT** ...Current humidity is displayed.
The humidity is displayed in a range from 30 to 80%
 - When the humidity is less than 30%: "30%" is displayed.
 - When the humidity is more than 80%: "80%" is displayed.
- **SELECTION** ...Humidity Setting is displayed.
(Only in ECO AUTO mode)

Before Using Your Dehumidifier

Setting the PM2.5 filter

The PM2.5 filter is supplied with the unit at time of purchase. Please install it before using the unit.

- 1 Remove the PM2.5 filter from the polyethylene bag.
- 2 Remove the pre-filter.

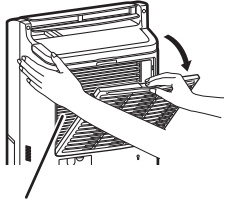

Pull the pre-filter toward you, and then remove it.

Performance is unaffected even if the metal fin inside the unit are slightly bent.

- 3 Set the PM2.5 filter.

With the strips facing up, set the filter inside the tabs on the pre-filter.

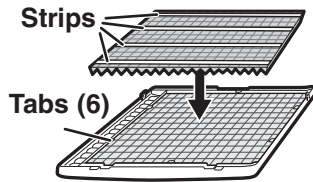

- 4 Set the pre-filter.

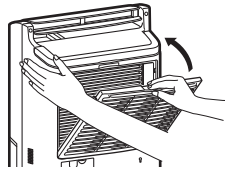

Insert the bottom tabs into the unit until they click.

Note

- Make sure the PM2.5 filter is attached on the unit. If it is not, fine dust will enter inside the unit and cause a malfunction.

Inserting the water tank correctly

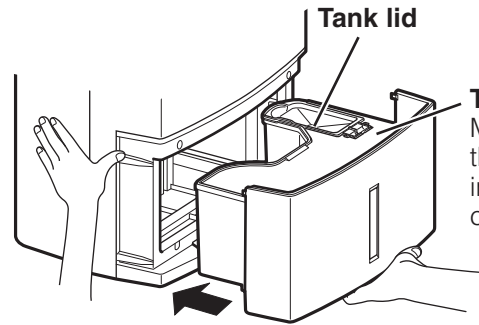

Tank guard
Make sure the tank is inserted correctly.

Plugging the power cord into the power socket

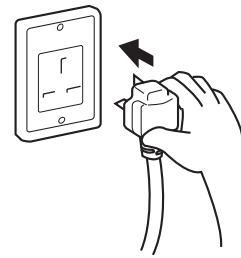

Use a 220V AC power socket only.

- **The current humidity is indicated.**

If the louvre is open, it closes automatically.

E

Before Using the Unit

Carrying the Unit

Hold the handle and move it.

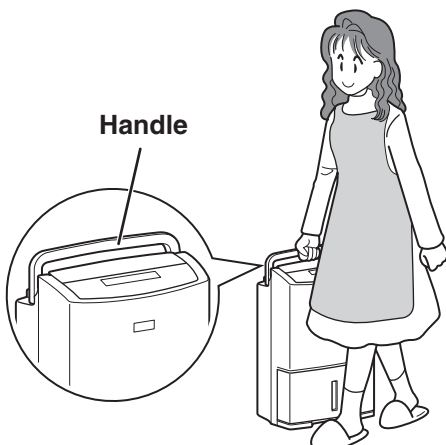

Casters can be used to move the unit.

First make sure to remove water from the water tank and close the louvre before carrying the unit.

- If casters are unable to roll smoothly, do not use excessive force to move this unit so as to prevent overturning.
- Do not carry the unit by holding the louvre.

Note

- Do not put the unit in horizontal position during carrying as this may cause malfunctions.
- Use casters to move the unit steadily in one direction.
- Lift the unit up to go over the doorsill or stairs and do not use casters to move the unit over the shaggy carpet as this may damage the carpet.
- Do not allow the power cord to be pulled into the casters, as this may damage the cord.

Drying Laundry

When in the operation of INTELLIGENT LAUNDRY, the unit stops automatically when the laundry is dry.

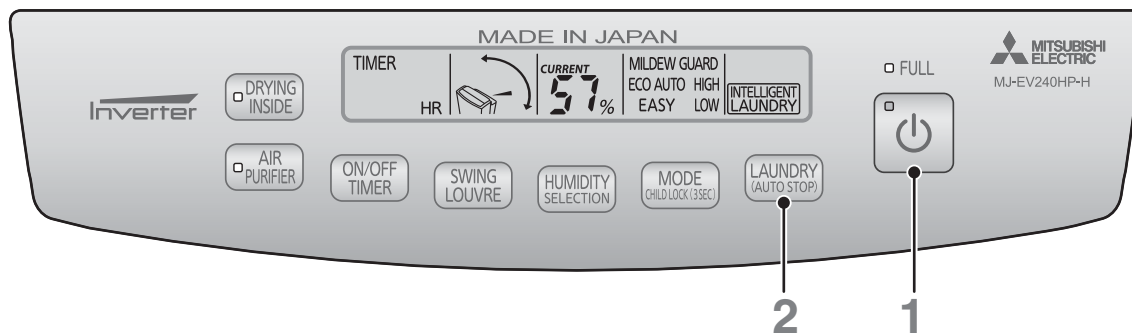

1 Press



- The operation mode is displayed.
- Inverter indicator lights.
- Louvre opens, and blows air.

2 Press **LAUNDRY (AUTO STOP)** to select **INTELLIGENT LAUNDRY**.

- A border is displayed around **INTELLIGENT LAUNDRY**



Please use swinging louvre to send air all over the laundry. **P16**

- Information**
- It is impossible to preset humidity when in INTELLIGENT LAUNDRY mode. In INTELLIGENT LAUNDRY mode, press HUMIDITY SELECTION switch to change into ECO AUTO mode. **P12**

<To stop operation>

Press



- The operation mode indicator goes out.
- Inverter indicator goes out.

- Information**
- If the DRYING INSIDE (auto) operation has been activated, the DRYING INSIDE operation will start after the unit stops. **P18**

Information

- After the unit stops or the power plug is inserted, the compressor will not be activated (for compressor protection). The dehumidifier will begin to work in 3 minutes after pressing the POWER switch. The noise emitted from the unit will become louder when the unit begins to dehumidify.
- The dehumidifier remembers the operation mode. Even if the plug is disconnected or the power is turned off, the unit restarts at the previous setting.

INTELLIGENT LAUNDRY

The unit controls the airflow rate while monitoring the humidity in the room, and automatically stops operating when the laundry is dry. Operation time is approximately 1 hour and can be up to approximately 12 hours.

Information

- Remove the water from the tank before operating the unit. The unit may stop operating when the tank is full before the laundry is dry.
- When it is used with the OFF TIMER operation mode, the unit may stop operating before the laundry is dry. **P17**
- If the room temperature is approximately 5°C or less, it becomes difficult for water to evaporate from the laundry, and the operation will stop in around 1 hour. At this time, please use the HIGH operation mode.

Tips on Drying Laundry

Make full use of the laundry drying operation to shorten the laundry drying time.

How to Hang Clothes

- Pull to remove any wrinkles on the laundry.
- Properly space the laundry for better ventilation (approximately 5 cm between the laundry).
- Hang out the laundry which is difficult to dry to the place with good ventilation.

The drying time for the thicker parts of the laundry is probably longer.

<The following conditions will cause longer drying time>

- The laundry is of a large volume.
- The room temperature is lower. P5
When the temperature is low (approximately 10°C), the drying time is twice as long as that at normal temperature (approximately 20°C).
- The room is big.

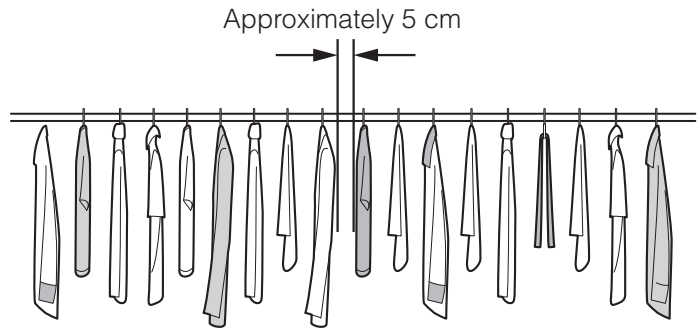

How to Blow Air at Clothes

- Use swinging louvre to send air all over the laundry. P16

The drying time of the part where the air cannot reach is longer.

- The laundry is of a large volume.

Shift the position of the laundry during drying so that each part can get the blowing air.

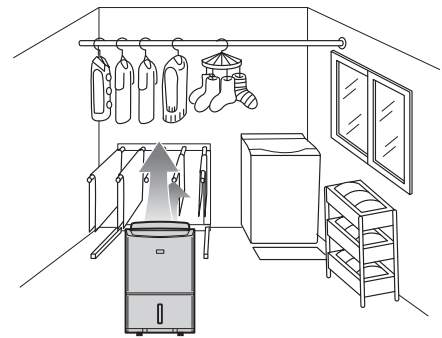

About the Room for Hanging Clothes

- In a small room, it is recommended that the door and window be closed before dehumidifying.

It is effective not only to dehumidify, but also to dry the laundry as soon as possible.

- When the room temperature is low such as in winter

Use a heater in combination with the dehumidifier in order to raise the room temperature to approximately 16°C or more, so that it is easy to dry the laundry.

Using the unit to dry clothes hung in a room is recommended on days such as the following.

- Cloudy and rainy days



During the days of high humidity weather, the laundry will take a long time to dry.

- Days with a lot of pollen and dust in the air



Drying the laundry indoor can prevent pollen particles and other dirt from attaching to the laundry.

- Days you are unable to bring in the laundry during daylight hours



After sunset, as the outdoor air becomes cool, the dried laundry will absorb moisture.

Dehumidifying

The operation mode can be selected accordingly to the situation.

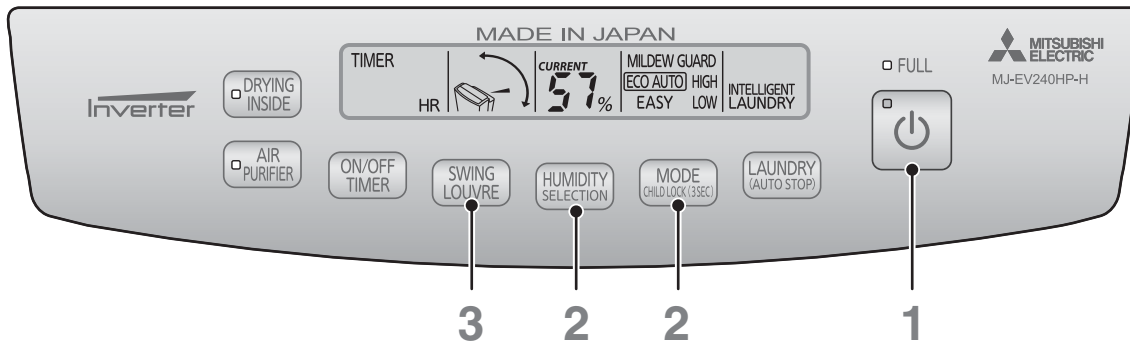

1 Press  ^{Blip} to begin operation.

- The operation mode is displayed.
- Inverter indicator lights.
- Louvre opens, and blows air.

2 Select the operation mode.

- To select the dehumidifying mode and operate

Press  P13-14

- The operation mode switches each time the button is pressed.



- To set the humidity and operate

Press  P13

- The set humidity changes each time the button is pressed.

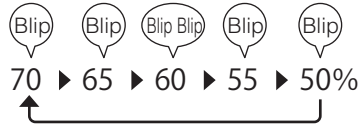

3 Press  and select the swing direction. P16

<To stop operation>

Press  ^{Blip}

- The operation mode indicator goes out.
- Inverter indicator goes out.

Note

- This dehumidifier remembers the operation mode. Even if the power plug is disconnected or the operation turned off, the dehumidifier will start operation with the same settings as the previous time.
- The humidity cannot be set in modes other than "ECO AUTO".
- Operation stops when the tank is full. To restart operation, remove water from the tank. If a continuous drainage hose is set, the dehumidifier will operate continuously. P20
- In the case of a power outage during operation, the dehumidifier will restart operation upon restoration in the operation mode before the power outage.
- If DRYING INSIDE operation is set, DRYING INSIDE operation will be carried out after the dehumidifier operation is stopped. P18

ECO AUTO

In order to maintain the humidity level, the unit operates intermittently after automatic switching of air flow rate.

- When the current humidity is lower than the set value, the unit will stop (both the blower/louvre will stop). It will restart if the humidity level is higher than the set value.
- For 6 minutes after the power is on, the unit will begin operating regardless of the room humidity.

Information

- Sometimes it would take a long time to bring down the humidity depending on opening and closing frequency of the room door or the size or shape of the room.

<To confirm the humidity setting>

- After displaying **SELECTION**, the current humidity setting is displayed.



After approximately 3 seconds, the display returns to the current humidity display.

EASY

To relieve the discomfort from dampness, the unit operates intermittently after the automatic switching of airflow rate. Blowing air is used to control the room temperature rise if the room temperature is high. It is recommended when you want to maintain the comfortable level of humidity.

- If the set humidity level is reached, sometimes the blower/louvre will stop operating.

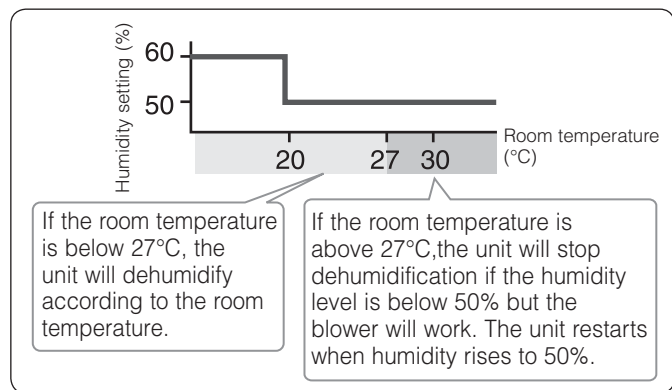

HIGH

The blower operates continuously in HIGH airflow mode. The rotation speed of the compressor motor is increased. It is recommended for strong dehumidification.

LOW

The blower operates continuously in LOW airflow mode. The rotation speed of the compressor motor is decreased. It is recommended when you want to dehumidify with lower blower sounds.

Dehumidifying (Cont.)

MILDEW GUARD

In this mode, the unit can dehumidify the bathroom to remove residual moisture and water drops, thus suppressing the mildew growth as a means of mildew prevention.

To install the unit

Install the unit in the changing room
(entrance to the bathroom)
(Do not install inside the bathroom)

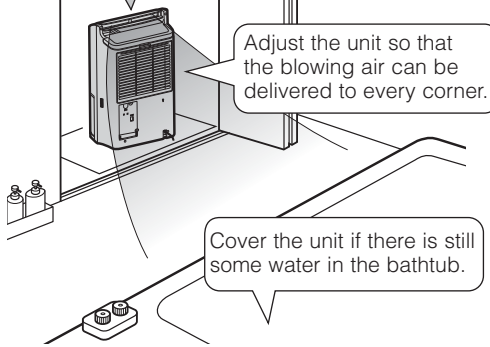

CAUTION



Do not use the unit in a bathroom or other location where it is likely to come into contact with water, or wash it with water.

Exposure to water may result in fire or electric shock caused by an electric leak.

Information

- For better results, do not turn on the room ventilation fan or open the window or door when the unit is operating.
- The results may vary depending on the size, floor and wall materials of the bathroom.
- There may be some residual water drops in the places that can collect water.
- Mildew growth may still occur due to the fungus type and conditions of the room.
<e.g.> Under the containers of the bathroom, deeper inside of closets and behind furniture and places with bad air flow.
- Places such as inside of the bathtub, under containers or where the blowing air cannot reach, cannot be dried.
- This mode does not remove existing mildew, scales and sticky liquids around the sinkhole.
- When it is used with the OFF TIMER mode, the unit may stop operating before completing the drying operation.

About MILDEW GUARD mode

The unit continues to operate for about another 4 hours after the humidity decreases to 50% and then stops automatically.

The operation time varies depending on temperature and humidity and ranges from approximately 4 hours (approximately 6 hours if the room temperature is below 20°C) to approximately 12 hours.

How is mildew growth suppressed?



Mildew is unable to produce new spores if it is dried as mycelia. This principle is applied to the MILDEW GUARD function. (However, the spores have high resistance to dryness.)

"Research of Black Mold"
Research paper by Dr. K. Abe of
Environmental Biology Research Center

Cleaning the Air (AIR PURIFIER)

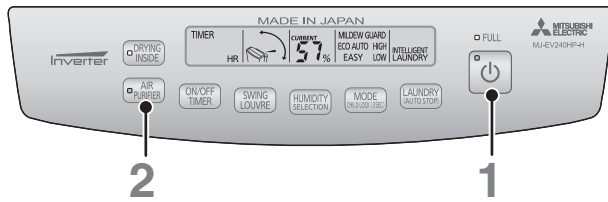
To operate only the air purifier.



- 1 Press  Blip
- 2 Press  Blip

- AIR PURIFIER lamp lights.

To return to the previous mode, press the AIR PURIFIER switch again.

● AIR PURIFIER

The unit cleans the air by passing it through the pre-filter and PM2.5 filter. The dehumidifier function is disabled.

Information

- The air passes through the PM2.5 filter in all modes, cleaning the air even if the AIR PURIFIER lamp is not lit.
- Cigarette smoke and toxins found in smoke, such as carbon monoxide, cannot be removed with these filters.

Replacement Parts

The PM2.5 filter is a consumable part. Please replace the filter regularly.

Replacing PM2.5 filter

The PM2.5 filter is a consumable part.

If the filter is dirty, replace it with a new one. (The filter cannot be reused even if it is washed)

Conditions to replace

The PM2.5 filter has turned yellow or black due to cigarette smoke or dust.

The lifetime of the PM2.5 filter is one year. (It varies depending on the usage conditions)

Remove the pre-filter and replace the PM2.5 filter.

Removing the filter P9

Parts sold separately

PM2.5 filter for replacement

- Type: MJPR-EHPFT-HK

Contact the Mitsubishi Electric Service Centre for purchase. P24

Using Child Lock

The switches can be locked.

To prevent children from operating this unit, use this function.

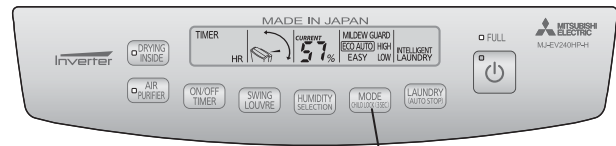

Press for 3 seconds or more.



- The child lock indicator is displayed. (Example)

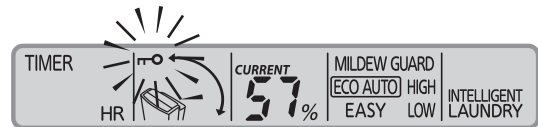

- If you lock the unit when the POWER is OFF.

The unit will not turn on, even if you press the POWER switch to turn it on. The LCD backlight and child lock indicator will blink.

- If you lock the unit when the POWER is ON.

The unit will not turn off, even if you press the POWER switch to turn it off. Only the child lock indicator will blink.

Information

- When the child lock is set, only the CHILD LOCK switch can be used. When the child lock is activated, other switches are not operable. Deactivate the child lock to use the other switches.
- The child lock is cancelled when the power cord is unplugged.

<Releasing the child lock>

Press  for 3 seconds or more.

- The child lock indicator goes out. (Example)

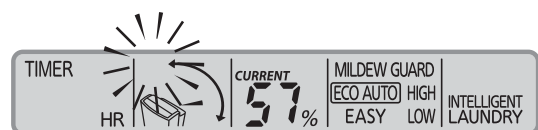

Operating

Using Louvre

The louvre can be made to swing. Select from the 4 possible settings to suit the purpose.

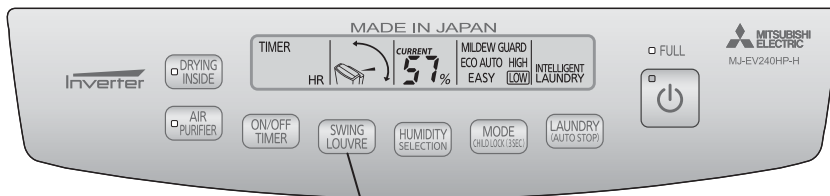

- Automatic louvre starts
- The monitor displays louvre direction

Remove the plug from the power socket and connect again, automatic louvre stops.

**Displays louvre swing range
(The louvre and monitor do not move in synchronization.)**

Each time the switch is pressed, the swing direction changes.

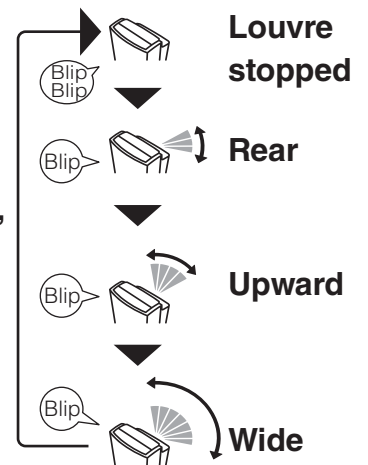

Objective	Recommended swing mode	Explanation of swing
To stop the louvre at the desired angle	<ul style="list-style-type: none"> • Louvre stopped 	Louvre stops in a vertical position, and louvre display screen will disappear. To change louvre to a desired angle, adjust the louvre angle by hand.
To dehumidify closets	<ul style="list-style-type: none"> • Rear 	The louvre swings to send air to the back of the unit.
To dry the laundry	<ul style="list-style-type: none"> • Upward 	The louvre swing speed is automatically controlled so that there is even distribution of air supply to the laundry. The louvre moves slowly through the last 20° of the swing, as it takes shorter time to traverse the upward arc than the rear arc when louvre moves at a constant speed.
To cover the entire room	<ul style="list-style-type: none"> • Wide 	The louvre swings from the upward position to the rear position to send air to all corners of the room.

- Information**
- The level of noise emitted from the unit varies depending on the air-blowing direction.
 - To locate the position, the air outlet may stop up to 8 seconds and then start operating again.
 - If the louvre is touched by hand or object, the louvre angle will change, so readjust the louvre by pressing the louvre switch.
 - If air is blown directly onto a wall, the wall may become dirty because of dust in the air.
 - This dehumidifier memorizes the swing direction but not the desired angle at which the louvre was stopped. The next time you start it, it returns to the default setting (upward).

Using Timer

OFF TIMER operation

The OFF TIMER can be set between 1 to 12 hours. Set the timer when the power is switched on.

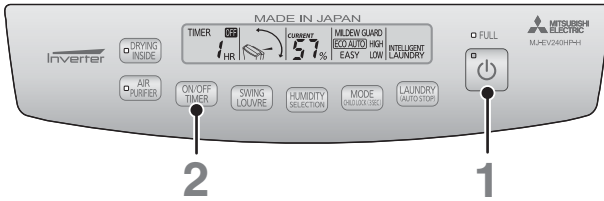

ON TIMER operation

The ON TIMER can be set between 1 to 12 hours. Set the timer when the POWER is off.

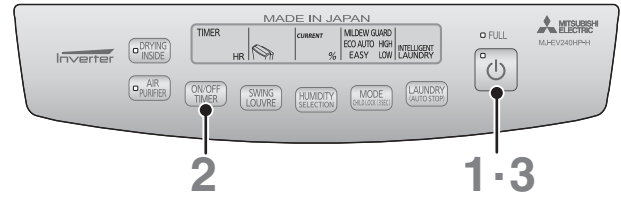

Setting OFF TIMER

1 Switch the power ON.

- Select operation mode. P10-14
- Select the louvre swing direction. P16

2 Set the operation time.



- Press once to display “?” “OFF”.
- Each press will change the display in the sequence of 1 to 12 hours.

(Holding the switch will cause the display to change continuously.)



→ The OFF TIMER is set.

- The remaining time will decrease one hour after each hour elapses.
- When the set time is reached, the unit stops automatically and the louvre closes automatically. DRYING INSIDE (auto) operation will start if it has been activated. P18

Cancellation

<When you want to stop operation>

Press POWER switch → OFF

<When you want to disable the OFF TIMER mode and continue operation>

Press and hold the ON/OFF TIMER switch until the remaining time disappears from the display.

Setting ON TIMER

1 Switch the power OFF.

2 Set the time you wish the unit to turn ON.



- Press once, the operation mode indicator and “?” on the digital display flash, and “ON” is displayed.
- Each press will change the display in the sequence of 1 to 12 hours.

(Holding the switch will cause the display to change continuously)

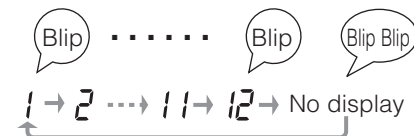

3 Confirm the time setting by pressing the POWER switch.



- Select operation mode. P10-14
Set the DRYING INSIDE (auto) operation as desired. P18
- Select the louvre swing direction. P16

- The timer display lights.
→ The ON TIMER is set.

If both the timer display and operation mode indicator blink, it means the POWER switch is not pressed. (An alarm “blip blip” sounds for 1 minute.)

- The remaining time will decrease one hour after each hour elapses.
- When the set time is reached, the unit automatically starts.

Cancellation

Press POWER switch → OFF

- When the ON TIMER is set during the DRYING INSIDE operation, the operation is stopped.
- The ON TIMER function is not operable using a commercially-available timer plug.

- Empty the water tank before operating. During operation, if the tank becomes full, the FULL lamp lights and the unit stops.
- The OFF TIMER and ON TIMER cannot be set at the same time.
- If the OFF TIMER mode is used with the INTELLIGENT LAUNDRY or MILDEW GUARD, the unit may stop before the laundry or the bathroom is dry.
- The OFF TIMER cannot be set during DRYING INSIDE operation.

Drying Inside Operation

The inside of the unit can be dried to suppress mildew growth on the cooler.

The DRYING INSIDE operation is recommended after each use of the unit (approx. 1 hour).

However, when continuous operation is being performed by continuous drainage (setting hose), there is no need to perform the DRYING INSIDE operation. Perform it when the operation is stopped.

Automatic Operation

To activate DRYING INSIDE operation after each use

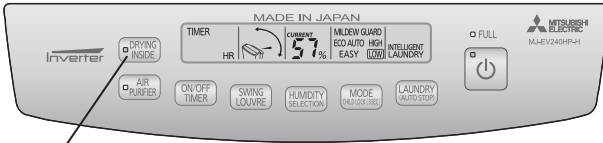

- **DRYING INSIDE operation standby** (DRYING INSIDE lamp lights.)

DRYING INSIDE operation starts when dehumidifying ends.

- **DRYING INSIDE operation starts.**
The DRYING INSIDE lamp flashes, the humidity indicator turns off, and the louvre stops in the vertical position.

DRYING INSIDE Operation

- **DRYING INSIDE operation ends.**
The DRYING INSIDE lamp turns off and the louvre closes.

<To deactivate the automatic operation>

Press  when the POWER is ON. (The DRYING INSIDE lamp turns off.)

Manual Operation

The DRYING INSIDE operation can only start when the POWER is OFF.

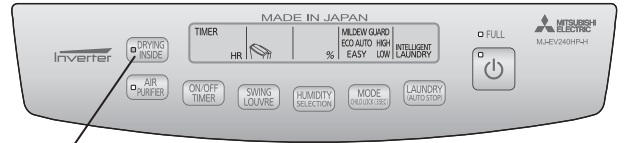



- **DRYING INSIDE operation starts.**
The DRYING INSIDE lamp flashes, the humidity indicator turns off, and the louvre stops in the vertical position.

DRYING INSIDE Operation

- **DRYING INSIDE operation ends.**
The DRYING INSIDE lamp turns off and the louvre closes.

To abort DRYING INSIDE operation

Press  while the unit is performing the DRYING INSIDE operation (the DRYING INSIDE lamp turns off).

Press  to abort the DRYING INSIDE operation and resume the regular operation.

Information

- Disconnecting the power plug will stop the automatic operation.
- This function does not remove existing mildew. Also, aborting the DRYING INSIDE operation may cause the benefits to diminish.
- During DRYING INSIDE operation, do not close the louvre. It will cause noise.
- The moisture expelled from inside the unit may cause the room humidity level to rise.
- The air emitting from the unit may appear white depending on the humidity or temperature of the room.
- The moisture expelled from inside the unit may have a smell due to odorants, which have not been caught by the filter and dissolve in water.
- During DRYING INSIDE operation, the OFF TIMER cannot be set.
- If operation is stopped while the FULL lamp is lit, the DRYING INSIDE operation cannot be set unless the power is turned off.

Draining

When the tank is full (approximately 5.5 L), the unit automatically stops and the FULL lamp lights. Please empty the tank.

When the water tank becomes full, the FULL lamp lights.

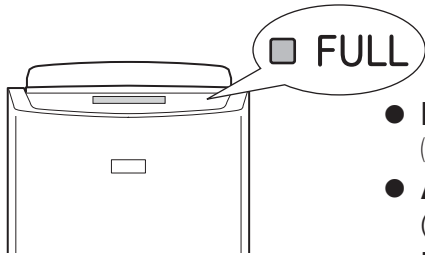

- **FULL lamp lights.**
(There will be continuous sounds "bleep bleep bleep".)
- **Airflow stops.**
(Louvre stops.)
- **LCD indicators go out.**

Information

- After pouring out the water, replace the water tank, and the FULL lamp will go out. The unit restarts.
- When the FULL lamp is on, other operations are forbidden except for pressing the POWER switch.
- In OFF TIMER operation, the FULL lamp is ON as indicator.

1 Remove the water tank.

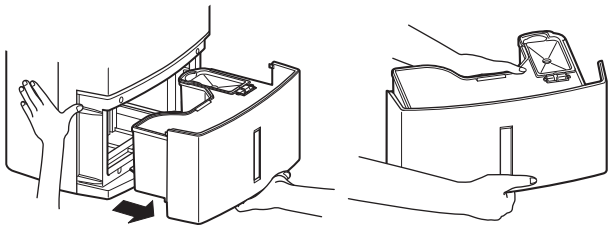

Slide the tank out steadily. Hold the water tank.

2 Remove the tank lid, and pour out the water.

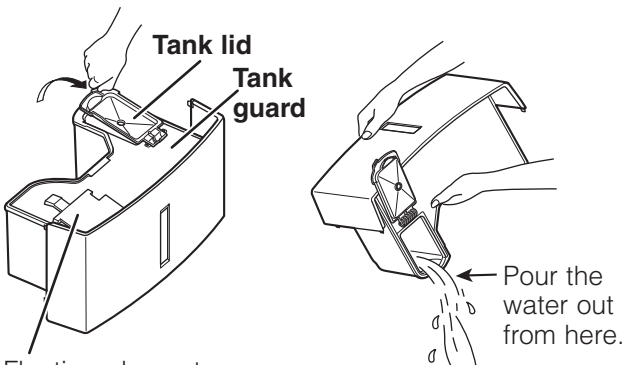

Floating element
Do not remove or dismantle.

Pour the water out from here.

3 Close the tank lid.

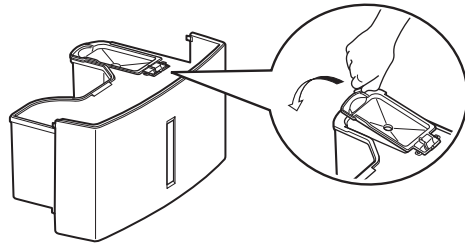

4 Check the tank, and firmly push it all the way in.

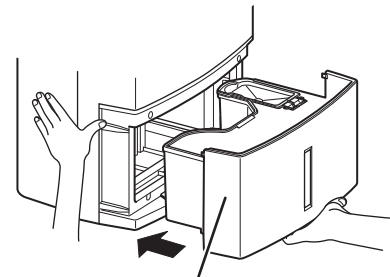

Tank
Make sure the tank is not broken or cracked.

Confirm that the tank lid and the tank guard are securely attached, and push the tank in. (Sounds "Blip".)

- If the tank lid and the tank guard are not properly replaced, you may have problems removing the water tank.
- If the water tank is not installed correctly, the FULL lamp will light and the unit will not operate.

Information

If the tank is not installed correctly, the FULL lamp will come on, and the unit will not operate.

Note

- Secure the tank lid and tank guard properly or else the tank may become stuck.
- Do not remove or dismantle the floating element from the tank. If it is removed, the unit cannot detect the water level, and this could result in leakage.

Continuous Drainage

If a drain is available, the unit can continuously drain water by attaching a commercially available hose (with an internal diameter of 15 mm) to the drain. As the unit does not stop due to the water tank being full, it can be operated for a long period of time without the need to empty the water tank. If there is power outage during operation, once power is restored, the unit resumes in the mode it was operating before power outage.

Items to prepare

- Commercially available hose (ID 15 mm)
Long enough to reach the drain from the dehumidifier.

CAUTION



Do not drain water continuously if there is a possibility that temperature around the hose could drop to freezing point.

Water inside the hose may freeze and prevent the water in the tank from flowing out. The water may leak from the unit and damage surrounding objects.



When draining water continuously or left unattended for long periods, inspect the unit every two weeks.

When the filter or hose is clogged with foreign materials or dirt, the dehumidification operation is disabled and may cause leakage.

Turn off the power switch and unplug the power cord.

1 Remove the water tank.

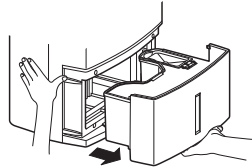

2 Open the power cord storage case.

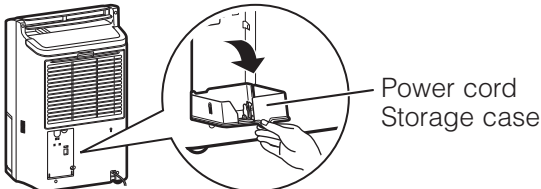

3 Pull the drainage outlet stopper.

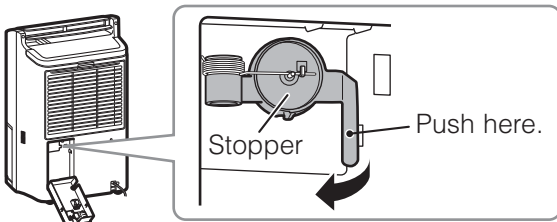

4 Insert the hose.

- ① Keep the stopper pulled out, and push in the commercially available hose firmly and straight into the drainage outlet.

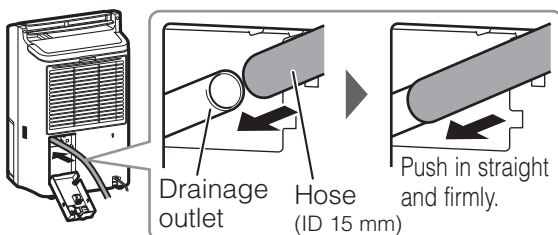

- ② Pull lightly to confirm that the hose does not come out.

5 Close the power cord storage case.

- ① Fix the continuous drainage outlet.

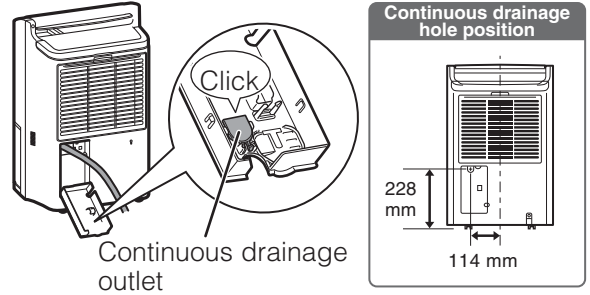

- ② Close the power cord storage case.

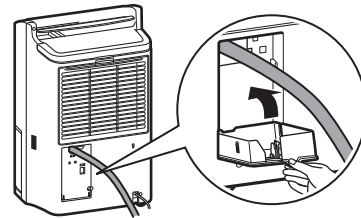

6 Attach the tank to the unit, and set the end of the hose into the drain.

If the tank is not reattached, the FULL lamp remains ON and operation is not possible.

Drainage Hose Installation Example

Correct	Incorrect	
	Hose is immersed in water.	Hose is higher than the drainage outlet.
	Hose is going over a step.	<ul style="list-style-type: none"> • Water will not be drained. • Water will be collected in the water tank. When the tank becomes full, the unit operation will stop.

Note

- Make sure the hose is in good condition free of bends and cracks.
- If it is hard to insert the hose, put it in water and then insert it. Do not use oils or lubricants. It may damage the unit.
- To stop continuous drainage, remove the hose, put the tank and use.
- Do not use the power plug with the power plug being stored in the power cord storage case.

Maintenance

Do not use detergents, cleaning agents for heat exchange equipment, decontaminative powders, chemically treated cloth, gasoline, volatile oil, thinners, etc. They can damage the water tank or main body, which may result in leakage.

Once Every Two Weeks

Rear air intake • pre-filter • PM2.5 filter • sensor

Clogged pre-filter will reduce the effectiveness of dehumidifying. Clean it every two weeks is desirable. Pre-filter needs not to be replaced unless it is damaged or broken.

- 1 Remove the pre-filter **P9** and use a vacuum cleaner to suck up the dirt from the rear air intake and sensor.

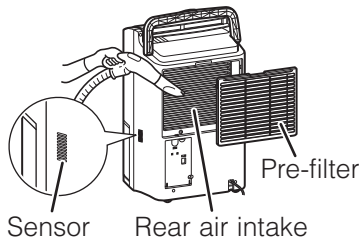

- 2 Remove the PM2.5 filter from the pre-filter.

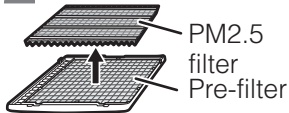

The PM2.5 filter cannot be washed. If the PM2.5 filter is dirty, replace it. **P15**

- 3 Use a vacuum cleaner to suck up the dirt.

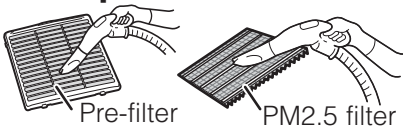

If the pre-filter is very dirty, wash it with normal or lukewarm water and dry it thoroughly.

- 4 Set the PM2.5 filter and pre-filter. **P9**

When Cleaning the Unit

Water tank • Main body

Wipe with a soft cloth.



Floating element

Do not remove or dismantle.

- Because the dust in the air may cause the tank lid and water tank to become dirty. If the dirt cannot be removed, wash with water then wipe with a dry cloth.
- Mildew may form in the water tank when the dirt is not removed thoroughly.

Storage

After switching the unit POWER off, leave for one day until any residual water inside is removed. Then carry out the following steps.

- 1 Perform the DRYING INSIDE operation. **P18**

DRYING INSIDE operation is recommended for prevention of mildew growth inside the unit.

- 2 Hang the power cord on the storage hook or put it into the power cord storage case.

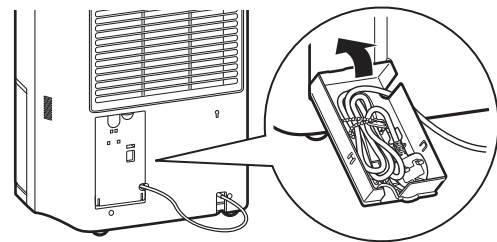
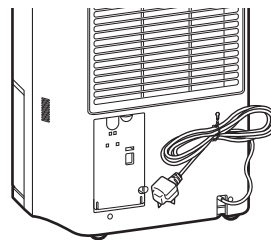

- 3 Drain out the water.

Drain any water from the water tank and wipe off any remaining water.

P19



- 4 Clean the pre-filter and PM2.5 filter.

Use a vacuum cleaner to suck up dirt.

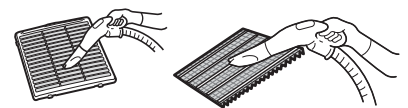

- 5 Store the unit.

- Dry the unit fully and cover it with a cloth or similar item to protect the unit from dust.
- Store the unit in a place not exposed to direct sunlight and with less humid, and keep it in upright position.

E

Operating

Troubleshooting

Troubleshooting

● For the symptoms listed below, refer to the remedies listed right.

Symptom	Cause/Remedy
The unit blows warm air.	<ul style="list-style-type: none"> ● The unit blows out warm air because dehumidified air passes through the re-heater. (There is no cooler function.) This is not a malfunction. P6
Water does not collect in the water tank (minimal dehumidifying results).	<ul style="list-style-type: none"> ● Check to see if the temperature/humidity is low. At first, confirm the current humidity. Low humidity reduces dehumidifying effectiveness. (In winter, the dry air makes the humidity low, and the amount of water collected is decreased.) This is not a malfunction. P6
<p>The unit does not operate (no air comes out and the louvre does not swing).</p> <p>The unit stops.</p> <p>Stops after a short time.</p> <p><input type="checkbox"/> FULL lights.</p>	<ul style="list-style-type: none"> ● Check to see whether the power cord is off. <ul style="list-style-type: none"> → Plug the power cord fully into the power socket. P9 ● Check to see if anything is blocking the air intake or outlet. <ul style="list-style-type: none"> → Remove the obstruction. P4
	<ul style="list-style-type: none"> ● Check to see if the operation is performed in ECO AUTO and EASY mode. <ul style="list-style-type: none"> → The unit automatically switches from dehumidification to air blowing and stops. P12-13
	<ul style="list-style-type: none"> ● Check to see if operation is being performed in the MILDEW GUARD mode. <ul style="list-style-type: none"> → This operation ends automatically when the humidity drops and will stop in 4 hours as minimum. P12-14
	<ul style="list-style-type: none"> ● Check to see if the pre-filter is clogged. <ul style="list-style-type: none"> → Clean according to the "Maintenance" procedures. P21
	<ul style="list-style-type: none"> ● Check to see if operation is being performed in the INTELLIGENT LAUNDRY mode. <ul style="list-style-type: none"> → If the room temperature drops to approximately 5°C or below, the operation will stop in approximately one hour. The reason for this is that if the room temperature is too low, it becomes difficult to remove moisture from the laundry and humidity does not change. P10
The unit continues to operate even though it is turned OFF.	<ul style="list-style-type: none"> ● Check to see if the unit is in DRYING INSIDE operation. The unit starts DRYING INSIDE operation automatically after ending normal operations. P18
The humidity level does not drop to the set level easily.	<ul style="list-style-type: none"> ● Check to see if the room is too large. <ul style="list-style-type: none"> → Use the unit for the specified area range. P24 ● Check to see if the windows and doors are opened too often. <ul style="list-style-type: none"> → Try to keep the room closed during operation. ● Check to see if steam producing appliances such as kerosene heaters are on in the vicinity.
The hygrometer reading on the unit differs from other hygrometers in the room.	<ul style="list-style-type: none"> ● Hygrometer readings differ from place to place even if in the same room. Use the unit humidity reading as an estimate. P6
The louvre does not work as set.	<ul style="list-style-type: none"> ● Press the SWING LOUVRE switch again. P16
The louvre remains open when it stops.	<ul style="list-style-type: none"> ● When the power lamp is ON, it operates intermittently. ● When the operation ends, the louvre closes.
The water tank contains liquid or white water residue.	<ul style="list-style-type: none"> ● The residue is from final product testing at the factory and is not a malfunction.
There is black residue on the inside of the water tank and lid.	<ul style="list-style-type: none"> ● The residue is from the dirt in the air. <ul style="list-style-type: none"> → Clean according to the "Maintenance" procedures. P21



Symptom		Cause/Remedy
The unit makes noises.	The operating noise is loud/reverberates.	<ul style="list-style-type: none"> ● Check to see if the unit is on a slope or uneven surface which causes the unit to tilt or wobble. → Move to a safe and even surface. P4 ● Check to see if the pre-filter is clogged. → Clean according to the methods specified in the "Maintenance" section. P21 ● Operating the unit on a wood board or in a small room is likely to cause acoustic resonance. → Placing a soft mat underneath the unit can reduce the acoustic resonance. P5
	The operating sound suddenly increases in volume.	<ul style="list-style-type: none"> ● Sound increases when the compressor starts operation. (Approximately three minutes after turning on the unit, or during ECO AUTO and EASY operation.)
	The air blowing sound changes in volume.	<ul style="list-style-type: none"> ● The volume of the sound differs depending on the louvre angle. P16
	The unit produces a simmering sound.	<ul style="list-style-type: none"> ● This is the sound of the refrigerant flow. The sound can be heard when the unit is turned on, during operation, or when operation stops. No sound can be heard when the refrigerant flow stabilizes.
	The unit produces a buzz that sounds intermittently (or the compressor does not activate).	<ul style="list-style-type: none"> ● This is the sound of the compressor when it starts up. In ECO AUTO and EASY modes, the compressor operates intermittently, so there is compressor startup sound. The compressor does not start when the operation ends or until 3 minutes has passed after the unit is turned on. This is to protect the compressor from damage.
The unit produces an odor.	When first used	<ul style="list-style-type: none"> ● The temperature of heat exchanger goes up rapidly, causing transient odor.
	During DRYING INSIDE operation	<ul style="list-style-type: none"> ● The discharged moisture may emit an odor. It is common that the filter cannot eliminate all the odors and the odors can be absorbed by moisture inside the unit.
The power plug or power socket generates abnormal heat.		<ul style="list-style-type: none"> ● Stop operation and contact the Mitsubishi Electric Service Centre.

● **Error message (Humidity indicator)**

Digital Display	Cause/Remedy
<i>b1</i> or <i>b3</i> appears.	<ul style="list-style-type: none"> ● Check to see if the power cord is plugged properly. → Correctly plug the power cord into the power socket.
<i>P4</i> , <i>Fb</i> , or <i>FE</i> appears.	<ul style="list-style-type: none"> ● Check to see if anything is blocking the air outlet. → Remove the obstruction and plug the power cord into the power socket again. ● Check to see if the pre-filter is clogged. → Clean according to the "Maintenance" procedures. P21
<i>AB</i> , <i>AB</i> , <i>b2</i> , <i>C1-C4</i> , <i>CA-CE</i> , <i>ED-E9</i> , <i>EA-EC</i> , <i>FD-F2</i> , <i>FC</i> , or <i>Fd</i> appears.	<ul style="list-style-type: none"> ● Malfunction → Take note of error message, unplug the power cord, and contact the Mitsubishi Electric Service Centre.

- If the symptoms persist even after following the prescribed remedies, or the error message does not disappear, unplug the power cord, and contact the Mitsubishi Electric Service Centre.
- If the power cord is damaged, it must be replaced by the manufacturer, its services agent or similar qualified persons in order to avoid a hazard.
- When unplugging and plugging back the power code into the power socket, wait at least one minute before plugging it in.

Specifications

Model		MJ-EV240HP-H	
Power supply		Single phase 220 V 50 Hz	
Condition	Temperature	26.7°C	30°C
	Relative humidity	60%	80%
Dehumidifying capacity*¹		24.0 L/day	36.0 L/day
Power consumption		400 W	500 W
Recommended room size*²	HIGH*³	100 m²	
	EASY	67 m²	
Water tank capacity		Stops automatically at approx. 5.5 L	
Weight		18.1 kg	
Dimensions (H × W × D)		630 mm × 410 mm × 299 mm	

*¹ The dehumidifying capacity is the averaged amount of moisture removed per day (24 hours).

*² House condition: Concrete house

*³ Dehumidifying area: According to standards of JEMA

Disposal

Dispose according to the garbage regulations in your district.

- PM2.5 filter
Material: PET and PS
- Unit
Do not disassemble. Dispose according to the garbage regulations in your district.

Sole Agent in Hong Kong
Mitsubishi Electric (Hong Kong) Ltd.
Head office -Tel.:2510 0555, Service Centre – Tel.: 2427 8484

Please complete the following form for your future reference.

Place of Purchase:		Telephone Number:	
Authorised Service Centre:		Telephone number:	
Date of Purchase:	Day	Month	Year

MITSUBISHI ELECTRIC CORPORATION