

## SPLIT-TYPE AIR CONDITIONERS

### INDOOR UNIT

MSY-JY09VF MSY-JY12VF MSY-JY18VF



MSY-JY24VF



#### OPERATING INSTRUCTIONS

For user

- To use this unit correctly and safely, be sure to read these operating instructions before use.

#### 操作手冊

使用者

- 為了確保正確和安全使用，請在使用之前仔細閱讀本操作手冊。

English

中文

# CONTENTS

■ SAFETY PRECAUTIONS	1
■ NAME OF EACH PART	5
■ PREPARATION BEFORE OPERATION	7
■ SELECTING OPERATION MODES	8
■ FAN SPEED AND AIRFLOW DIRECTION ADJUSTMENT	9
■ FAST COOLING OPERATION	10
■ TIMER OPERATION (ON/OFF TIMER)	10
■ EMERGENCY OPERATION	11
■ SLEEP OPERATION	12
■ CLEANING	13
■ WHEN YOU THINK THAT TROUBLE HAS OCCURRED	15
■ ERROR CODE DISPLAY MODE	17
■ WHEN THE AIR CONDITIONER IS NOT GOING TO BE USED FOR A LONG TIME	19
■ INSTALLATION PLACE AND ELECTRICAL WORK	19
■ SPECIFICATIONS	20

# SAFETY PRECAUTIONS

## Meanings of symbols displayed on indoor unit and/or outdoor unit

	<b>WARNING</b> (Risk of fire)	This unit uses a flammable refrigerant. If refrigerant leaks and comes in contact with fire or heating part, it will create harmful gas and there is risk of fire.
		Read the OPERATING INSTRUCTIONS carefully before operation.
		Service personnel are required to carefully read the OPERATING INSTRUCTIONS and INSTALLATION MANUAL before operation.
		Further information is available in the OPERATING INSTRUCTIONS, INSTALLATION MANUAL, and the like.









- Since rotating parts and parts which could cause an electric shock are used in this product, be sure to read these "Safety Precautions" before use.
- Since the cautionary items shown here are important for safety, be sure to observe them.
- After reading this manual, keep it together with the installation manual in a handy place for easy reference.
- Be sure to receive a guarantee card from your dealer and check that the purchased date and shop name, etc. are entered correctly.

### Marks and their meanings







- WARNING** : Incorrect handling could cause serious hazard, such as death, serious injury, etc. with a high probability.
- CAUTION** : Incorrect handling could cause serious hazard depending on the conditions.

# SAFETY PRECAUTIONS

## Meanings of symbols used in this manual

- |   |  |   |  |
|---|--|---|--|
|  | : Be sure not to do.   |  | : Danger of electric shock. Be careful.                              |
|  | : Be sure to follow the instruction.                                       |  | : Be sure to disconnect the power supply plug from the power outlet. |
|  | : Never insert your finger or stick, etc.                                  |  | : Be sure to shut off the power.                                     |
|  | : Never step onto the indoor/outdoor unit and do not put anything on them. |  | : Risk of fire   |

## WARNING

	<b>Do not connect the power cord to an intermediate point, use an extension cord, or connect multiple devices to a single AC outlet.</b> • This may cause overheating, fire, or electric shock.
	<b>Make sure the power plug is free of dirt and insert it securely into the outlet.</b> • A dirty plug may cause fire or electric shock.
	<b>Do not bundle, pull, damage, or modify the power cord, and do not apply heat or place heavy objects on it.</b> • This may cause fire or electric shock.
	<b>Do not turn the breaker OFF/ON or disconnect/connect the power plug during operation.</b> • This may create sparks, which can cause fire. • After the indoor unit is switched OFF with the remote controller, make sure to turn the breaker OFF or disconnect the power plug.
	<b>Do not expose your body directly to cool air for a prolonged length of time.</b> • This could be detrimental to your health.
	<b>The unit should not be installed, relocated, disassembled, altered, or repaired by the user.</b> • An improperly handled air conditioner may cause fire, electric shock, injury, or water leakage, etc. Consult your dealer. • If the power supply cord is damaged, it must be replaced by the manufacturer or its service agent in order to avoid a hazard.
	<b>When installing, relocating, or servicing the unit, make sure that no substance other than the specified refrigerant (R32) enters the refrigerant circuit.</b> • Any presence of foreign substance such as air can cause abnormal pressure rise and may result in explosion or injury. • The use of any refrigerant other than that specified for the system will cause mechanical failure, system malfunction, or unit breakdown. In the worst case, this could lead to a serious impediment to securing product safety.
<b>This appliance is not intended for use by persons (including children) with reduced physical, sensory or mental capabilities, or lack of experience and knowledge, unless they have been given supervision or instruction concerning use of the appliance by a person responsible for their safety.</b> <b>Children should be supervised to ensure that they do not play with the appliance.</b>	
 	<b>Do not insert your finger, a stick, or other objects into the air inlet or outlet.</b> • This may cause injury, since the fan inside rotates at high speeds during operation.
 	<b>In case of an abnormal condition (such as a burning smell), stop the air conditioner and disconnect the power plug or turn the breaker OFF.</b> • A continued operation in the abnormal state may cause a malfunction, fire, or electric shock. In this case, consult your dealer.
 	<b>When the air conditioner does not cool or heat, there is a possibility of refrigerant leakage. If any refrigerant leakage is found, stop operations and ventilate the room well and consult your dealer immediately. If a repair involves recharging the unit with refrigerant, ask the service technician for details.</b> • The refrigerant used in the air conditioner is not harmful. Normally, it does not leak. However, if refrigerant leaks and comes in contact with fire or heating part of such a fan heater, kerosene heater, or cooking stove, it will create harmful gas and there is risk of fire.

# SAFETY PRECAUTIONS

## ⚠ WARNING



**The user should never attempt to wash the inside of the indoor unit. Should the inside of the unit require cleaning, contact your dealer.**

- Unsuitable detergent may cause damage to plastic material inside the unit, which may result in water leakage. Should detergent come in contact with electrical parts or the motor, it will result in a malfunction, smoke, or fire.
- The appliance shall be stored in a room without continuously operating ignition sources (for example: open flames, an operating gas appliance or an operating electric heater).
- Be aware that refrigerants may not contain an odour.
- Do not use means to accelerate the defrosting process or to clean the appliance, other than those recommended by the manufacturer.
- Do not pierce or burn.

**The indoor unit must be installed in rooms which exceed the floor space specified. Please consult your dealer.**

## ⚠ CAUTION



**Do not touch the air inlet or the aluminum fins of the indoor/outdoor unit.**

- This may cause injury.

**Do not use insecticides or flammable sprays on the unit.**

- This may cause a fire or deformation of the unit.

**Do not expose pets or houseplants to direct airflow.**

- This may cause injury to the pets or plants.

**Do not place other electric appliances or furniture under the indoor/outdoor unit.**

- Water may drip down from the unit, which may cause damage or malfunction.

**Do not leave the unit on a damaged installation stand.**

- The unit may fall and cause injury.

**Do not step on an unstable bench to operate or clean the unit.**

- This may cause injury if you fall down.

**Do not pull the power cord.**

- This may cause a portion of the core wire to break, which may cause overheating or fire.

**Do not charge or disassemble the batteries, and do not throw them into a fire.**

- This may cause the batteries to leak, or cause a fire or explosion.

**Do not operate the unit for more than 4 hours at high humidity (80% RH or more) and/or with windows or outside door left open.**

- This may cause the water condensation in the air conditioner, which may drip down, wetting or damaging the furniture.
- The water condensation in the air conditioner may contribute to growth of fungi, such as mold.

**Do not use the unit for special purposes, such as storing food, raising animals, growing plants, or preserving precision devices or art objects.**

- This may cause deterioration of quality, or harm to animals and plants.

**Do not expose combustion appliances to direct airflow.**

- This may cause incomplete combustion.

**Never put batteries in your mouth for any reason to avoid accidental ingestion.**

- Battery ingestion may cause choking and/or poisoning.



**Before cleaning the unit, switch it OFF and disconnect the power plug or turn the breaker OFF.**

- This may cause injury, since the fan inside rotates at high speeds during operation.

**When the unit will be unused for a long time, disconnect the power plug or turn the breaker OFF.**

- The unit may accumulate dirt, which may cause overheating or fire.

**Replace all batteries of the remote controller with new ones of the same type.**

- Using an old battery together with a new one may cause overheating, leakage, or explosion.

**If the battery fluid comes in contact with your skin or clothes, wash them thoroughly with clean water.**

- If the battery fluid comes in contact with your eyes, wash them thoroughly with clean water and immediately seek medical attention.

# SAFETY PRECAUTIONS

## ⚠ CAUTION

⚠	<p><b>Ensure that the area is well-ventilated when the unit is operated together with a combustion appliance.</b></p> <ul style="list-style-type: none"> <li>Inadequate ventilation may cause oxygen starvation.</li> </ul>
	<p><b>Turn the breaker OFF when you hear thunder and there is a possibility of a lightning strike.</b></p> <ul style="list-style-type: none"> <li>The unit may be damaged if lightning strikes.</li> </ul>
	<p><b>After the air conditioner is used for several seasons, perform inspection and maintenance in addition to normal cleaning.</b></p> <ul style="list-style-type: none"> <li>Dirt or dust in the unit may create an unpleasant odor, contribute to growth of fungi, such as mold, or clog the drain passage, and cause water to leak from the indoor unit. Consult your dealer for inspection and maintenance, which require specialized knowledge and skills.</li> </ul>
⚡	<p><b>Do not operate switches with wet hands.</b></p> <ul style="list-style-type: none"> <li>This may cause electric shock.</li> </ul>
	<p><b>Do not clean the air conditioner with water or place an object that contains water, such as a flower vase, on it.</b></p> <ul style="list-style-type: none"> <li>This may cause fire or electric shock.</li> </ul>
⊘	<p><b>Do not step on or place any object on the outdoor unit.</b></p> <ul style="list-style-type: none"> <li>This may cause injury if you or the object falls down.</li> </ul>

## ⚠ IMPORTANT

Dirty filters cause condensation in the air conditioner which will contribute to the growth of fungi such as mold. It is therefore recommended to clean air filters every 2 weeks.

## For installation

## ⚠ WARNING

⊘	<p><b>Consult your dealer for installing the air conditioner.</b></p> <ul style="list-style-type: none"> <li>It should not be installed by the user since installation requires specialized knowledge and skills. An improperly installed air conditioner may cause water leakage, fire, or electric shock.</li> </ul>
	<p><b>Provide a dedicated power supply for the air conditioner.</b></p> <ul style="list-style-type: none"> <li>A non-dedicated power supply may cause overheating or fire.</li> </ul>
	<p><b>Do not install the unit where flammable gas could leak.</b></p> <ul style="list-style-type: none"> <li>If gas leaks and accumulates around the outdoor unit, it may cause an explosion.</li> </ul>
⚠	<p><b>Earth the unit correctly.</b></p> <ul style="list-style-type: none"> <li>Do not connect the earth wire to a gas pipe, water pipe, lightning rod, or a telephone earth wire. Improper earthing may cause electric shock.</li> </ul>

## ⚠ CAUTION

⚠	<p><b>Install an earth leakage breaker depending on the installation location of the air conditioner (such as highly humid areas).</b></p> <ul style="list-style-type: none"> <li>If an earth leakage breaker is not installed, it may cause electric shock.</li> </ul>
	<p><b>Ensure that the drain water is properly drained.</b></p> <ul style="list-style-type: none"> <li>If the drain passage is improper, water may drip down from the indoor/outdoor unit, wetting and damaging the furniture.</li> </ul>

### In case of an abnormal condition

Immediately stop operating the air conditioner and consult your dealer.

# NAME OF EACH PART

## Indoor unit <JY09/12/18>

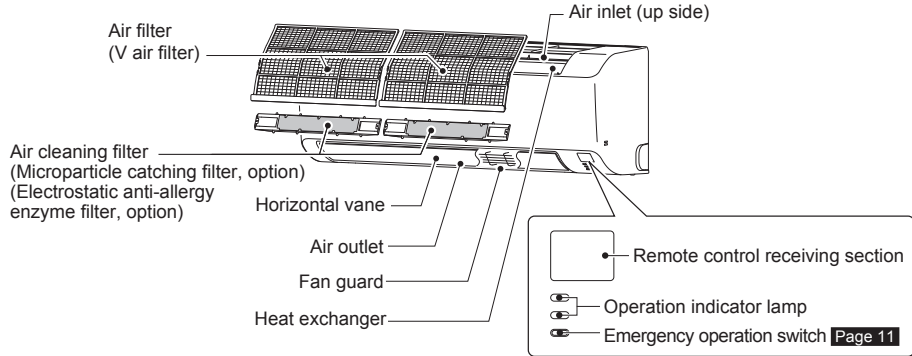

## <JY24>

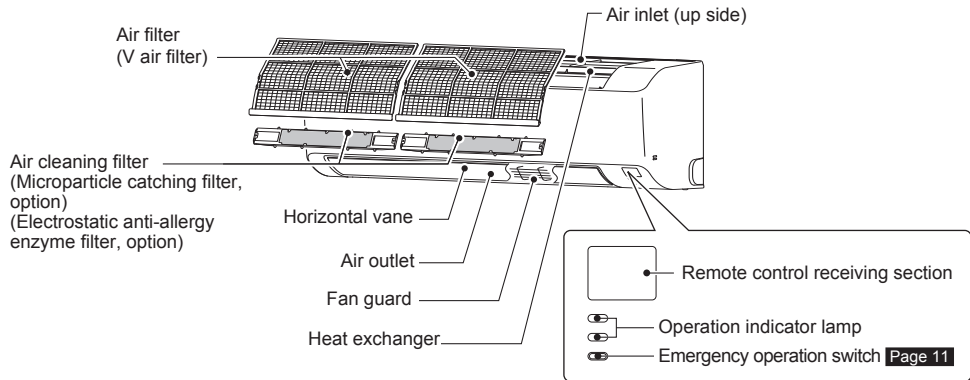

## Outdoor unit

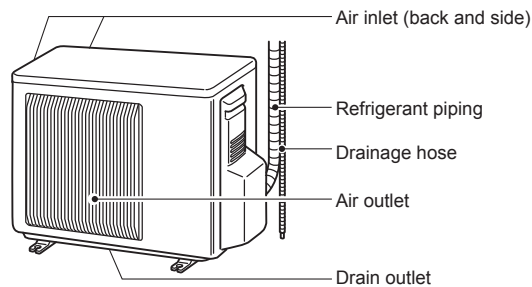

Outdoor units may be different in appearance.

# NAME OF EACH PART

## Remote controller

Signal transmitting section  
 Distance of signal : About 6 m\*  
 Beep(s) is (are) heard from the indoor unit when the signal is received.

\* Refer to **page 17** for ERROR CODE DISPLAY MODE.

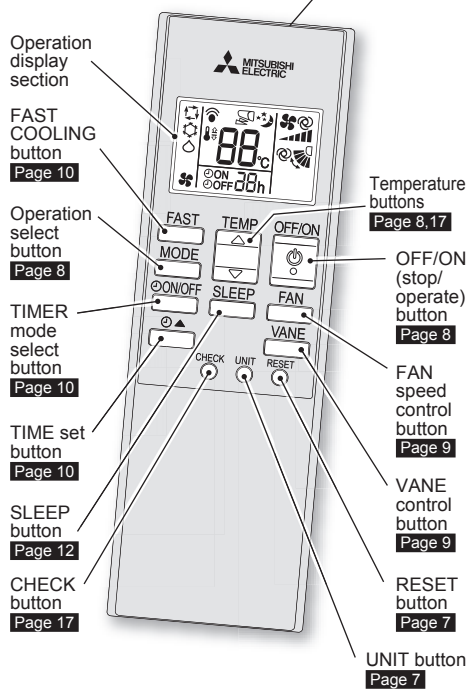

Only use the remote controller provided with the unit.  
 Do not use other remote controllers.  
 If two or more indoor units are installed in proximity to one another, an indoor unit that is not intended to be operated may respond to the remote controller.

### Remote controller hook

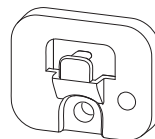

- Install the remote controller hook in a place where the signal can be received by the indoor unit.

# PREPARATION BEFORE OPERATION

**Before operation:** Insert the power supply plug into the power outlet and/or turn the breaker on.

## Installing the remote controller batteries

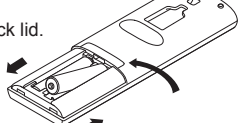
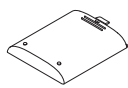
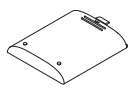
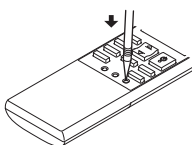
1. Remove the back lid. 
2. Insert the negative pole of AAA alkaline batteries first. 
3. Install the back lid. 
4. Press RESET. 

### Note:

- Make sure the polarity of the batteries is correct.
- Do not use manganese batteries and leaking batteries. The remote controller could malfunction.
- Do not use rechargeable batteries.
- Replace all batteries with new ones of the same type.
- Batteries can be used for approximately 1 year. However, batteries with expired shelf lives last shorter.
- Press RESET gently using a thin instrument. If the RESET is not pressed, the remote controller may not operate correctly.

### Note:

#### How to set remote controller exclusively for a particular indoor unit

A maximum of 4 indoor units with wireless remote controllers can be set.

To operate the indoor unit individually with each remote controller, assign a number to each remote controller according to the number of the indoor unit. Please set according to the following procedure:

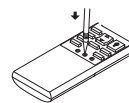

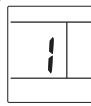
- (1) Turn the breaker OFF for the unit.
- (2) With the remote controller powered OFF, hold down UNIT on the remote controller for 2 seconds to enter the pairing mode. Setting number is displayed in the remote controller. 
- (3) Press UNIT again and assign a number to each remote controller. Each press of UNIT advances the number in the following order: 1→2→3→4.

- (4) Press  to complete the pairing setting.

After you turn the breaker ON, the remote controller that first sends a signal to an indoor unit will be regarded as the remote controller for the indoor unit.

Once they are set, the indoor unit will only receive the signal from the assigned remote controller afterwards.

The setting of indoor unit will be cancelled, if the breaker is turned OFF or the power supply is shut down.

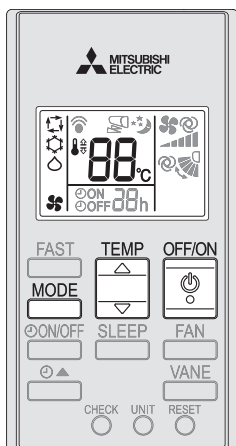

# SELECTING OPERATION MODES



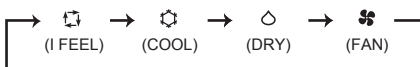

**1** Press  to start the operation.

**2** Press  to select operation mode. Each press changes mode in the following order:



**3** Press  or  to set the temperature. Each press raises or lowers the temperature by 1°C.



Press  to stop the operation.



- The same setting is selected the next time by simply pressing .

## Note:

### Operation indicator lamp

The operation indicator lamp shows the operation state of the unit.

Indication	Operation state	Room temperature
	The unit is operating to reach the set temperature	About 2°C or more away from set temperature
	The room temperature is approaching the set temperature	About 1 to 2°C from set temperature

 Lit       Not lit

## I FEEL mode

The unit selects the operation mode according to the room temperature when I FEEL is selected. When the room temperature is higher than 25°C, COOL is selected (set temperature: 24°C). When the room temperature is lower than 25°C, DRY is selected. However, when operation is stopped and then started within 2 hours, the mode which has been selected previously is operated.

## Note:

During COOL operation, the set temperature may not be changed when the room temperature is more than 2°C higher than the set temperature. In this case, please wait until the room temperature drops to within 2°C of the set temperature.

## COOL mode

Enjoy cool air at your desired temperature.

## DRY mode

Dehumidify your room. The room may be cooled slightly.  
Temperature cannot be set during DRY mode.

## FAN mode

Circulate the air in your room.

# FAN SPEED AND AIRFLOW DIRECTION ADJUSTMENT

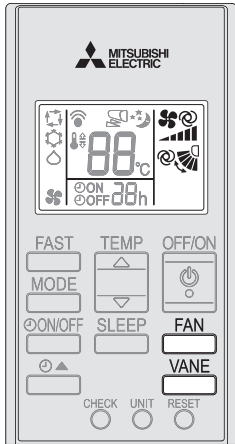

## Fan speed

1 Press **FAN** to select fan speed. Each press changes fan speed in the following order:

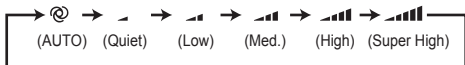

- Two short beeps are heard from the indoor unit when set to AUTO.
- Use higher fan speed to cool the room more powerfully. It is recommended to lower the fan speed once the room is cool.
- Use lower fan speed for quiet operation.
- Use lower fan speed to further lower the outlet temperature and humidity.

## Up-down Airflow direction

1 Press **VANE** to select airflow direction. Each press changes airflow direction in the following order:

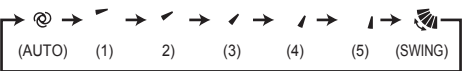

(AUTO) .....The vane is set to the most efficient airflow direction. :horizontal position.

(Manual) .....For efficient air conditioning, select the upper position for COOL/DRY, and the lower position for FAN. If the lower position is selected during COOL/DRY, the vane automatically moves to the upward position after 0.5 to 1 hour to prevent any condensation from dripping.

(Swing) .....The vane moves up and down intermittently.

- Two short beeps are heard from the indoor unit when set to AUTO.

## Left-right Airflow direction

### To change the horizontal airflow direction.

Move the vertical vanes from side to side by pinching the tabs indicated by arrows before starting operation.

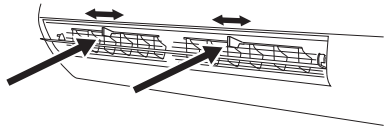

## FAST COOLING OPERATION

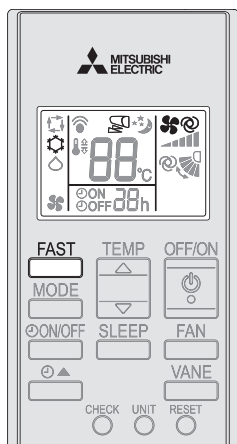

- 1 Press **FAST** during COOL mode **page 8** to start FAST COOLING operation.

Fan speed : Exclusive speed for FAST COOLING mode  
 Horizontal vane : The vane follows as your selection during Manual/Swing. Exclusive position during AUTO operation.

- Temperature cannot be set during FAST COOLING operation.

Press **FAST** again to cancel FAST COOLING operation.

- FAST COOLING operation is also cancelled automatically in 15 minutes, or when the MODE, OFF/ON or FAN button is pressed.

## TIMER OPERATION (ON/OFF TIMER)

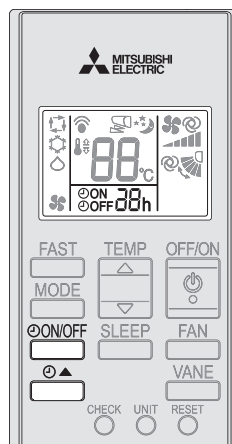

- 1 Press **ON/OFF** during operation to set the timer. Each press changes timer mode in the following order:



- 2 Press **UP** to set the time of timer. Press increases the set time by 1 hour.

Press **ON/OFF** until "TIMER RELEASE" is selected to release timer.

### Note:

- ON and OFF timers can not be used in combination.
- If power failure occurs while ON/OFF timer is set, see **page 11** "Auto restart function".

## EMERGENCY OPERATION

### When the remote controller cannot be used...

Emergency operation can be activated by pressing the emergency operation switch (E.O. SW) on the indoor unit.

#### <JY09/12/18/24>



Each time the E.O. SW is pressed, the operation changes in the following order:

#### Operation indicator lamp

Emergency COOL

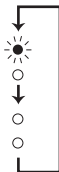

Stop

Set temperature : 24°C  
Fan speed : Medium  
Horizontal vane : Auto

#### Note:

The first 30 minutes of operation is test run. Temperature control does not work, and fan speed is set to High.

Auto-restart page missing

- Sam 2026/04/16

# SLEEP OPERATION

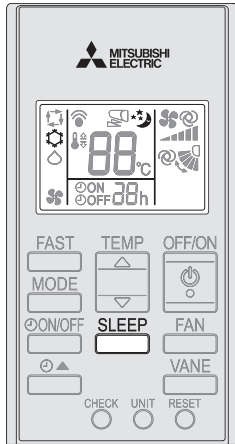

1

Press **SLEEP** during COOL mode **Page 8** to start SLEEP operation.

- Set temperature will change over time.
- Set temperature will be controlled slightly lower for about 2 hours.  
It will help you fall asleep more easily.
- Air direction can be changed as you like.
- SLEEP operation cannot be set when ON timer is on stand-by.

## SLEEP ON

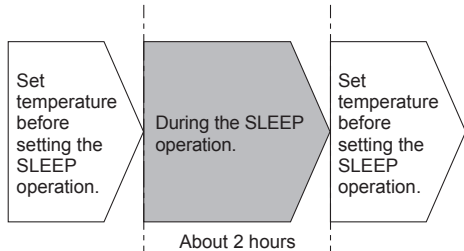

Press **SLEEP** again to cancel SLEEP operation.

- SLEEP operation is also cancelled when the MODE, FAST, OFF/ON or ON TIMER button is pressed.

# CLEANING

## Instructions:

- Switch off the power supply or turn off the breaker before cleaning.
- Be careful not to touch the metal parts with your hands.
- Do not use benzine, thinner, polishing powder, or insecticide.
- When dirt stands out, wash it with kitchen neutral detergent diluted with lukewarm water to the specified concentration, then wipe off the detergent with a damp towel.
- Do not expose parts to direct sunlight, heat, or fire to dry.
- Do not use water hotter than 50°C.
- Do not use a scrubbing brush, a hard sponge, or the like.
- Do not soak or rinse the horizontal vane.
- Do not apply excessive force on the fan as it may cause cracks or breakage.

### Air filter Page 14

<JY09/12/18>

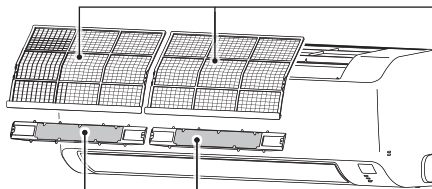

<JY24>

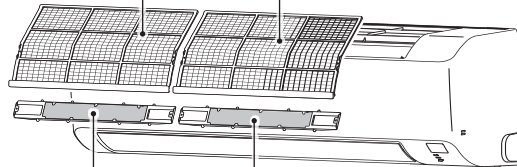

### Air cleaning filter Page 14

# CLEANING

## Air filter (V air filter)

### • **Clean every 2 weeks**

- Remove dirt by a vacuum cleaner, or rinse with water.
- After washing with water, dry it well in shade.
- V air filter has a virus-suppressing coating not only to improve air quality but also to eliminate bacteria and viruses.

## Air cleaning filter (Microparticle catching filter, option)

Removes the microparticles from the air by means of static electricity.

### Back side of air filter

#### Every 3 months:

- Remove dirt by a vacuum cleaner.
- Do not wash it with water. Replace it with a new air cleaning filter when tobacco tar or oil stains adhere to it.
- Put it back to its original position, and install all tabs of the air cleaning filter.

#### Every 3 year:

- Replace it with a new air cleaning filter for best performance.

#### • Parts Number

JY09/12/18	:	MAC-EMF915FT-E	(with frame)
	:	MAC-EMF925FT-E	(without frame)
JY24	:	MAC-EMF815FT-E	(with frame)
	:	MAC-EMF925FT-E	(without frame)

## Air cleaning filter (Electrostatic anti-allergy enzyme filter, option)

### Back side of air filter

#### Every 3 months:

- Remove dirt by a vacuum cleaner.
- Put it back to its original position, and install all tabs of the air cleaning filter.

#### When dirt cannot be removed by vacuum cleaning:

- Soak the filter and its frame in lukewarm water before rinsing it.
- After washing, dry it well in shade. Install all tabs of the air filter.

#### Every year:

- Replace it with a new air cleaning filter for best performance.

#### • Parts Number

JY09/12/18	:	MAC-2322FT	(with frame)
	:	MAC-2321FT	(without frame)
JY24	:	MAC-2323FT	(with frame)
	:	MAC-2321FT	(without frame)

### <JY09/12/18>

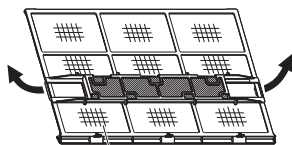

Remove the hooks on both sides and remove from the air filter.

### <JY24>

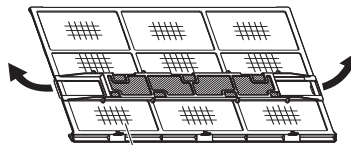

Remove the hooks on both sides and remove from the air filter.

### ! Important

- **Clean the filters regularly for best performance and to reduce power consumption.**
- **Dirty filters cause condensation in the air conditioner which will contribute to the growth of fungi such as mold. It is therefore recommended to clean air filters every 2 weeks.**

## WHEN YOU THINK THAT TROUBLE HAS OCCURRED

Even if these items are checked, when the unit does not recover from the trouble, stop using the air conditioner and consult your dealer.

Symptom	Explanation & Check points
<b>Indoor Unit</b>	
The unit cannot be operated.	<ul style="list-style-type: none"> <li>Is the breaker turned on?</li> <li>Is the power supply plug connected?</li> <li>Is the ON timer set? <a href="#">Page 10</a></li> </ul>
The horizontal vane does not move.	<ul style="list-style-type: none"> <li>Are the horizontal vane and the vertical vane installed correctly?</li> <li>Is the fan guard deformed?</li> </ul>
The unit cannot be operated for about 3 minutes when restarted.	<ul style="list-style-type: none"> <li>This protects the unit according to instructions from the microprocessor. Please wait.</li> </ul>
Mist is discharged from the air outlet of the indoor unit.	<ul style="list-style-type: none"> <li>The cool air from the unit rapidly cools moisture in the air inside the room, and it turns into mist.</li> </ul>
The swing operation of the HORIZONTAL VANE is suspended for a while, then restarted.	<ul style="list-style-type: none"> <li>This is for the swing operation of the HORIZONTAL VANE to be performed normally.</li> </ul>
The air flow direction changes during operation. The direction of the horizontal vane cannot be adjusted with the remote controller.	<ul style="list-style-type: none"> <li>When the unit is operated in COOL or DRY mode, if the operation continues with air blowing down for 0.5 to 1 hour, the direction of the air flow is automatically set to upward position to prevent water from condensing and dripping.</li> </ul>
The unit starts operation by itself when the main power is turned on, though it isn't operated with the remote controller.	<ul style="list-style-type: none"> <li>These models are equipped with an auto restart function. When the main power is turned off without stopping the unit with the remote controller and is turned on again, the unit starts operation automatically in the same mode as the one set with the remote controller just before the shutoff of the main power. Refer to "Auto restart function". <a href="#">Page 11</a></li> </ul>
The indoor unit discolors over time.	<ul style="list-style-type: none"> <li>Although plastic turns yellow due to the influence of some factors such as ultraviolet light and temperature, this has no effect on the product functions.</li> </ul>
<b>Outdoor Unit</b>	
The fan of the outdoor unit does not rotate even though the compressor is running. Even if the fan starts to rotate, it stops soon.	<ul style="list-style-type: none"> <li>When the outside temperature is low during cooling operation, the fan operates intermittently to maintain sufficient cooling capacity.</li> </ul>
Water leaks from the outdoor unit.	<ul style="list-style-type: none"> <li>During COOL and DRY operations, pipe or pipe connecting sections are cooled and this causes water to condense.</li> </ul>
<b>Remote controller</b>	
The display on the remote controller does not appear or it is dim. The indoor unit does not respond to the remote control signal.	<ul style="list-style-type: none"> <li>Are the batteries exhausted? <a href="#">Page 7</a></li> <li>Is the polarity (+, -) of the batteries correct? <a href="#">Page 7</a></li> <li>Are any buttons on the remote controller of other electric appliances being pressed?</li> </ul>

# WHEN YOU THINK THAT TROUBLE HAS OCCURRED

Symptom	Explanation & Check points
<b>Does not cool</b>	
The room cannot be cooled sufficiently.	<ul style="list-style-type: none"> <li>• Is the temperature setting appropriate? <b>Page 8</b></li> <li>• Is the fan setting appropriate? Please change fan speed to High or Super High. <b>Page 9</b></li> <li>• Are the filters clean? <b>Page 13</b></li> <li>• Is the fan or heat exchanger of the indoor unit clean?</li> <li>• Are there any obstacles blocking the air inlet or outlet of the indoor or outdoor unit?</li> <li>• Is a window or door open?</li> <li>• When a ventilation fan or a gas cooker is used in a room, the cooling load increases, resulting in an insufficient cooling effect.</li> <li>• When the outside temperature is high, the cooling effect may not be sufficient.</li> <li>• It may take a certain time to reach the setting temperature or may not reach that depending on the size of the room, the ambient temperature, and the like.</li> </ul>
<b>Airflow</b>	
The air from the indoor unit smells strange.	<ul style="list-style-type: none"> <li>• Are the filters clean? <b>Page 13</b></li> <li>• Is the fan or heat exchanger of the indoor unit clean?</li> <li>• The unit may suck in an odor adhering to the wall, carpet, furniture, cloth, etc. and blow it out with the air.</li> </ul>
<b>Sound</b>	
Cracking sound is heard.	<ul style="list-style-type: none"> <li>• This sound is generated by the expansion/contraction of the front panel, etc. due to change in temperature.</li> </ul>
"Bubbling" sound is heard.	<ul style="list-style-type: none"> <li>• This sound is heard when the outside air is absorbed from the drain hose by turning on the range hood or the ventilation fan, making water flowing in the drain hose to spout out. This sound is also heard when the outside air blows into the drain hose in case the outside wind is strong.</li> </ul>
Mechanical sound is heard from the indoor unit.	<ul style="list-style-type: none"> <li>• This is the switching sound in turning on/off the fan or the compressor.</li> </ul>
The sound of water flowing is heard.	<ul style="list-style-type: none"> <li>• This is the sound of refrigerant or condensed water flowing in the unit.</li> </ul>
Hissing sound is sometimes heard.	<ul style="list-style-type: none"> <li>• This is the sound when the flow of refrigerant inside the unit is switched.</li> </ul>

**In the following cases, stop using the air conditioner and consult your dealer.**

- When water leaks or drips from the indoor unit.
- When the left/upper operation indicator lamp blinks. **Page 17**  
Except for when the lamp of a multi unit blinks while the unit is on standby.
- When the breaker trips frequently.
- The remote control signal is not received in a room where an electronic ON/OFF type fluorescent lamp (inverter-type fluorescent lamp, etc.) is used.
- Operation of the air conditioner interferes with radio or TV reception. An amplifier may be required for the affected device.
- When an abnormal sound is heard.
- When any refrigerant leakage is found.

# ERROR CODE DISPLAY MODE

## Error code can be checked on the display of remote controller while the left/upper operation indicator lamp on the indoor unit is blinking.

Follow the procedure below to check the error code.

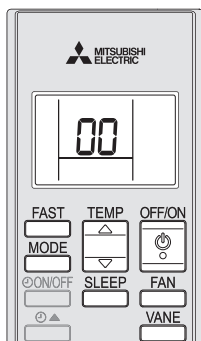

An example of error code (00)

### 1

#### Error code display

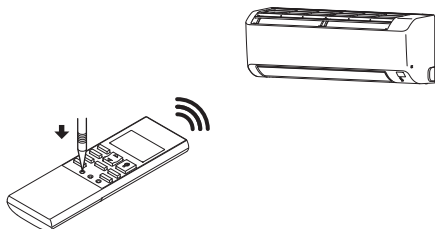

- The remote controller is powered OFF.
- Get close to the front of the indoor unit, point the remote controller at the receiving section of the indoor unit, and keep pressing CHECK with a fine-tipped object.
- "00" will be shown in the display.
- Keep pointing the remote controller at the receiving section of the indoor unit until the indoor unit beeps.
- If the indoor unit does not beep, get closer to the indoor unit and keep pressing CHECK again.
- If the indoor unit still does not beep, turn off the power of appliance such as fluorescent lamp and TV which might cause noise, then try again. (If the battery replacement indicator lights up, replace the batteries with new ones.)
- When the display of the remote controller shows "00" and the indoor unit beeps 2 times, it means the unit has no error.
- When the display of the remote controller shows "00" and the indoor unit beeps 1 time, it means the unit has an error. Follow the procedure below and diagnose the error.

### 2

#### Error code check

Press or to change an error code.

Each press changes the error code

shown on the remote controller in ascending order (A to Z) as below.

00 → E6 → . . . . . → UP



Each press changes the error code in descending order (Z to A).

Check the error codes 1 by 1 to send the signal.

The indoor unit beeps 2 times

: The unit has the error corresponding to the error code. Refer to the error code table and confirm the abnormal point.

The indoor unit beeps 1 time

: The unit has no error. Repeat checking.

The indoor unit does not beep

: The diagnosis gets a fail. Try again.

- When the unit has an error, the air conditioner needs to be inspected and repaired. Stop using the air conditioner, turn off the breaker and contact your dealer.

#### Note:

Pressing other buttons than or cancels the error code display mode of the remote controller.

If the remote controller is operated while the operation indicator lamp is not blinking, the accurate error code might not be shown.

# ERROR CODE DISPLAY MODE

## Error code of remote controller

Object	Code	Abnormal point
	00	None (Normal)
Indoor unit	E6	Serial signal
	E7	
	Fb	Indoor control system
	P1	Room temperature thermistor
	P2	Indoor coil thermistor
	P9	
	Pb	Indoor fan motor
Outdoor unit	E8	Indoor/outdoor communication, receiving error
	E9	
	EC	
	FC	Nonvolatile memory data
	Fd	Different voltage
	P8	4-way valve/Pipe temperature
	PL	Outdoor refrigerant system
	U3	Discharge temperature thermistor
	U4	Defrost thermistor
		Fin temperature thermistor
		P.C. board temperature thermistor
		Ambient temperature thermistor
		Outdoor heat exchanger temperature thermistor
	UE	Stop valve (Closed valve)
UP	Outdoor power system	

## WHEN THE AIR CONDITIONER IS NOT GOING TO BE USED FOR A LONG TIME

- 1 Operate by COOL mode with the highest temperature set or FAN mode for 3 to 4 hours. **Page 8**
  - This dries the inside of the unit.
  - Moisture in the air conditioner contributes to growth of fungi, such as mold.
- 2 Press  to stop the operation.
- 3 Turn off the breaker and/or disconnect the power supply plug.
- 4 Remove all batteries from the remote controller.

## When using the air conditioner again:

- 1 Clean the air filter. **Page 13**
- 2 Check that the air inlet and outlet of the indoor and outdoor units are not blocked.
- 3 Check that the earth is connected correctly.
- 4 Refer to the “PREPARATION BEFORE OPERATION”, and follow the instructions. **Page 7**

## INSTALLATION PLACE AND ELECTRICAL WORK

### Installation place

**Avoid installing the air conditioner in the following places.**

- Where there is much machine oil.
- Salty places such as the seaside.
- Where sulfide gas is generated such as hot spring, sewage, waste water.
- Where oil is splashed or where the area is filled with oily smoke (such as cooking areas and factories, in which the properties of plastic could be changed and damaged).
- Where there is high-frequency or wireless equipment.
- Where the air from the outdoor unit air outlet is blocked.
- Where the operation sound or air from the outdoor unit bothers the house next door.
- The mounting height of indoor unit 1.8 m to 2.3 m is recommended. If it is impossible, please consult your dealer.
- The indoor unit must be installed in rooms which exceed the floor space specified. Please consult your dealer.
- Do not operate the air conditioner during interior construction and finishing work, or while waxing the floor. Before operating the air conditioner, ventilate the room well after such work is performed. Otherwise, it may cause volatile elements to adhere inside the air conditioner, resulting in water leakage or scattering of dew.

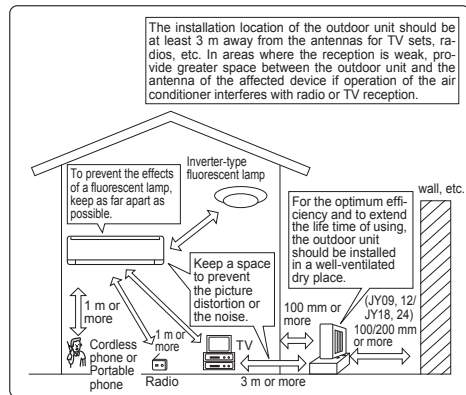

### Electrical work

- Provide an exclusive circuit for the power supply of the air conditioner.
- Be sure to observe the breaker capacity.

**If you have any questions, consult your dealer.**

# SPECIFICATIONS

Model		MSY-JY09VF	MSY-JY12VF	MSY-JY18VF
Dimensions H × W × D (mm)	Indoor	290 × 799 × 233	290 × 799 × 233	290 × 799 × 233
	Outdoor	454 × 660 × 235	454 × 660 × 235	538 × 699 × 249
Weight (kg)	Indoor	8.7	8.7	9.3
	Outdoor	17.2	20.3	25.7

Model		MSY-JY24VF
Dimensions H × W × D (mm)	Indoor	290 × 999 × 233
	Outdoor	714 × 800 × 285
Weight (kg)	Indoor	11.3
	Outdoor	28.1

Wong data

-Sam 2026/04/16

## Guaranteed operating range

	Indoor	Outdoor
Upper limit	32°C DB 23°C WB	46°C DB —
Lower limit	21°C DB 15°C WB	21°C DB —





DB: Dry Bulb  
WB: Wet Bulb

## 目錄

■ 安全注意事項	1
■ 各部件名稱	5
■ 操作前注意事項	7
■ 選擇運轉模式	8
■ 風速及風向調節	9
■ 快速製冷運轉	10
■ 定時運轉 (定時開/定時關)	10
■ 應急運轉	11
■ 睡眠操作	12
■ 清潔	13
■ 疑難排解疑難排解	15
■ 安裝位置及配電	17
■ 冷暖氣機長時間不使用時	19
■ 安裝位置及配電	19
■ 規格	20

## 安全注意事項

### 室內機組與/或室外機組上顯示的符號含義

	<b>警告</b> (火災危險)	本機使用易燃製冷劑。 如果發現製冷劑洩漏並接觸到火源或熱源，可能產生有害氣體並有火災危險。
	運轉之前，請仔細閱讀操作手冊。	
	維修人員操作之前應仔細閱讀操作手冊及安裝手冊。	
	操作手冊、安裝手冊等資料中有可用的詳細資訊。	

- 由於本產品內有旋轉零件以及可能造成觸電的零件，使用前請務必仔細閱讀「安全注意事項」。
- 此處所列注意事項對安全非常重要，請務必遵守。
- 閱讀本手冊之後，請將本手冊與安裝手冊一併妥善保管，以供日後參考。
- 請務必從經銷商處取得保養卡，並檢查上面是否正確輸入購買日期及店名等資料。

### 圖符號及其意義如下









- ⚠ 警告： 操作不當極可能導致嚴重傷害，如死亡、重傷等。
- ⚠ 注意： 視乎情況而定，操作不當可能導致嚴重傷害。

Tc-1







# 安全注意事項

本手冊所使用的符號意義如下

- |   |                         |   |                   |
|---|-------------------------|---|-------------------|
|  | : 禁止行為。                 |  | : 有觸電危險。請小心。      |
|  | : 請務必遵守指示。              |  | : 請務必從電源插座拔下電源插頭。 |
|  | : 請勿插入手指或棒狀物等。          |  | : 請務必關閉電源。        |
|  | : 切勿踏踏室內/室外機組，或在其上放置物品。 |  | : 火災危險            |



 <b>警告</b>	
	請勿在電源線中途引線、使用延長線，或與多台設備共用一個交流電源插座。 • 否則可能會導致過熱、火災或觸電。
	請確認電源插頭是否乾淨後，再插入插座。 • 粘附灰塵的插頭可能會導致火災或觸電。
	請勿捆綁、拉扯、損壞或修改電源線，也不要接觸熱源或在其上放置重物。 • 否則可能會導致火災或觸電。
	運轉時，請勿關/開斷電器，或拔下/插入電源插頭。 • 否則可能會引起火花，造成火災。 • 用遙控器關閉室內機組後，請務必關閉斷電器或拔下電源插頭。
	請勿長時間受到冷空氣直吹。 • 否則可能有健康。
	使用者不應自行安裝、移機、拆解、改裝或修理本機組。 • 冷暖氣機操作不當可能會導致火災、觸電、受傷或漏水等。請聯絡經銷商。 • 如果電源線損壞，必須由製造商或其服務代理商進行更換，以免發生危險。
	安裝、移機或維修機組時，除指定的製冷劑(R32)外，確保沒有其他異物進入製冷劑循環系統內。 • 任何異物（如空氣）均可令壓力異常上升，導致爆炸或受傷。 • 使用任何非系統專用的製冷劑，會導致機械故障、系統故障或機組損壞。最壞的情況下，此舉可能導致嚴重損害對產品安全的保障。
本設備並非設計給身體、感覺或心智功能不足者（包括孩童）、或缺乏經驗及知識者使用，除非有能確保其安全者給予監督或指導，才能使用本設備。 請注意避免讓孩童玩耍本設備。	
 	請勿將手指、棒狀物或其他物件插入進風口或出風口。 • 由於機組運轉時，內部風扇會高速旋轉，因此可能造成人身傷害。
 	如果發生異常，如燒焦味，請停止運轉，並拔下電源插頭或關閉斷電器。 • 若在發生異常狀況時繼續運轉，可能會導致機組故障、火災或觸電。在這種情況下，請聯絡經銷商。
 	如果冷暖氣機不能製冷或製熱，可能是因為製冷劑外洩。如果發現製冷劑洩漏，請立即停止運轉並為房間妥善通風，然後聯絡經銷商。如果維修時需要為機組填充製冷劑，請向維修技術人員查詢詳情。 • 冷暖氣機內使用的製冷劑無害。一般而言，製冷劑不會洩漏。然而，如果發現製冷劑洩漏並接觸到火源或暖風機、煤油爐、煮食爐等熱源，可能產生有害氣體並有火災危險。

## 安全注意事項

 <b>警告</b>	
 	<p><b>使用者不得試圖清洗室內機組內部。如需清潔本機組內部，請聯絡經銷商。</b></p> <ul style="list-style-type: none"><li>• 不適合的清潔劑可能會損壞本機組內部的塑膠材料，造成漏水。清潔劑接觸電子零件或馬達，會造成故障、冒煙或火災。</li><li>• 本設備應保管於無連續運作點火源（例如：明火、運作中的燃氣設備或電加熱器）的房間內。</li><li>• 請注意製冷劑可能無味。</li><li>• 除製造商建議的方式以外，不得以任何其他方式來加速除霜過程或清潔。</li><li>• 請勿拆解或燃燒。</li></ul>
	<p>室內機組必須安裝在超出額定樓面空間的房間內。請聯絡經銷商。</p>
 <b>注意</b>	
	<p>請勿接觸室內/室外機組的進風口或鋁片。</p> <ul style="list-style-type: none"><li>• 否則可能會導致受傷。</li></ul>
	<p>請勿在機組上使用殺蟲劑或易燃噴霧。</p> <ul style="list-style-type: none"><li>• 否則可能會導致火災或機組變形。</li></ul>
	<p>請勿使氣流直接吹向動植物。</p> <ul style="list-style-type: none"><li>• 否則可能會使動植物受到傷害。</li></ul>
	<p>室內/室外機組下方不得放置其他電器或家具。</p> <ul style="list-style-type: none"><li>• 機組可能會滴水，導致損壞或故障。</li></ul>
	<p>請勿將機組放在已損壞的安裝台上。</p> <ul style="list-style-type: none"><li>• 機組可能會掉落，造成傷害。</li></ul>
	<p>請勿站在不穩的椅子上操作或清潔機組。</p> <ul style="list-style-type: none"><li>• 否則可能跌下受傷。</li></ul>
	<p>請勿拉扯電源線。</p> <ul style="list-style-type: none"><li>• 否則可能使部分芯線斷裂，導致過熱或火災。</li></ul>
	<p>請勿對電池充電或拆解，或將其丟入火中。</p> <ul style="list-style-type: none"><li>• 否則可能導致電池漏液，或引起火災或爆炸。</li></ul>
	<p>請勿將機組置於高溫（80% RH或更高）環境和/或門窗持續開啟的狀態運轉超過 4 小時。</p> <ul style="list-style-type: none"><li>• 否則可能導致冷暖氣機的冷凝水滴落，弄濕或損壞家具。</li><li>• 冷暖氣機的冷凝水可能會造成霉菌等細菌滋生。</li></ul>
	<p>請勿將機組用於特殊用途，如儲放食物、飼養動物、種植植物或存放精密儀器或藝術品。</p> <ul style="list-style-type: none"><li>• 否則可能導致質變，或使動植物受到傷害。</li></ul>
	<p>請勿使氣流直吹燃燒器具。</p> <ul style="list-style-type: none"><li>• 否則可能導致無法燃燒。</li></ul>
	<p>切勿將電池放入口中，以免發生意外吞食。</p> <ul style="list-style-type: none"><li>• 吞食電池可能會導致窒息和/或中毒。</li></ul>
	<p>清潔機組前，請關閉機組，並拔下電源插頭或關閉斷電器。</p> <ul style="list-style-type: none"><li>• 由於機組運轉時，內部風扇會高速旋轉，因此可能造成人身傷害。</li></ul>
	<p>長期不使用機組時，請拔下電源插頭或關閉斷電器。</p> <ul style="list-style-type: none"><li>• 因為機組會積聚灰塵，導致過熱或火災。</li></ul>
	<p>更換遙控器的電池時，請使用同種類型的新電池。</p> <ul style="list-style-type: none"><li>• 如果混用新舊電池，可能會導致過熱、漏液或爆炸。</li></ul>
	<p>如果電解液接觸到皮膚或衣物，用清水沖洗乾淨。</p> <ul style="list-style-type: none"><li>• 如果電解液誤入眼睛，用清水沖洗乾淨並立即就醫。</li></ul>

## 安全注意事項

### ⚠ 注意



	機組與燃燒器具同時運轉時，請對該區域進行通風。 <ul style="list-style-type: none"><li>通風不良可能導致缺氧。</li></ul>
	打雷時請關閉斷電器，否則可能會受到雷擊。 <ul style="list-style-type: none"><li>機組受到雷擊可能會損壞。</li></ul>
	冷暖氣機使用一段時間之後，除了一般清潔之外，也要檢查並維護。 <ul style="list-style-type: none"><li>機組內的污垢或灰塵可能會發出異味，導致滋生霉菌等細菌，或堵塞排水通道使室內機組漏水。請聯絡經銷商，委託具有專業知識和技巧的人員進行檢查及維護工作。</li></ul>
	請勿用濕手操作開關。 <ul style="list-style-type: none"><li>否則可能導致觸電。</li></ul>
	請勿用清水清洗冷暖氣機，或將有水的物品（如花瓶）放在冷暖氣機上。 <ul style="list-style-type: none"><li>否則可能導致火災或觸電。</li></ul>
	請勿踐踏室外機組，或在其上放置物品。 <ul style="list-style-type: none"><li>跌下或物品摔落可能造成傷害。</li></ul>

### ❗ 重要

過濾網髒污會造成冷暖氣機中的水氣凝結，導致滋生霉菌等細菌。建議每 2 週清潔一次空氣過濾網。

## 安裝

### ⚠ 警告

	請聯絡經銷商安裝冷暖氣機。 <ul style="list-style-type: none"><li>安裝機組需要專業知識和技巧，使用者不應自行安裝。冷暖氣機安裝不當可能會導致漏水、火災或觸電。</li></ul>
	應為冷暖氣機配備獨立電源。 <ul style="list-style-type: none"><li>與其他設備共用一個電源可能會導致過熱或火災。</li></ul>
	請勿將機組安裝在可能會洩漏易燃氣體的位置。 <ul style="list-style-type: none"><li>如果氣體洩漏，並積聚在室外機組周圍，可能導致爆炸。</li></ul>
	將機組正確接地。 <ul style="list-style-type: none"><li>請勿將地線連接到燃氣管、水管、避雷針或電話地線。接地不當可能導致觸電。</li></ul>

### ⚠ 注意

	視乎冷暖氣機安裝位置而定（如高濕環境），安裝接地漏電斷電器。 <ul style="list-style-type: none"><li>未安裝接地漏電斷電器，可能會導致觸電。</li></ul>
	請確保排水通道排水順暢。 <ul style="list-style-type: none"><li>如果排水通道排水不暢，室內/室外機組可能會滴水，弄濕或損壞家具。</li></ul>

#### 發生異常狀況時

請立即停止冷暖氣機的運轉，並聯絡經銷商。

## 各部件名稱

### 室內機組 <JY09/12/18>

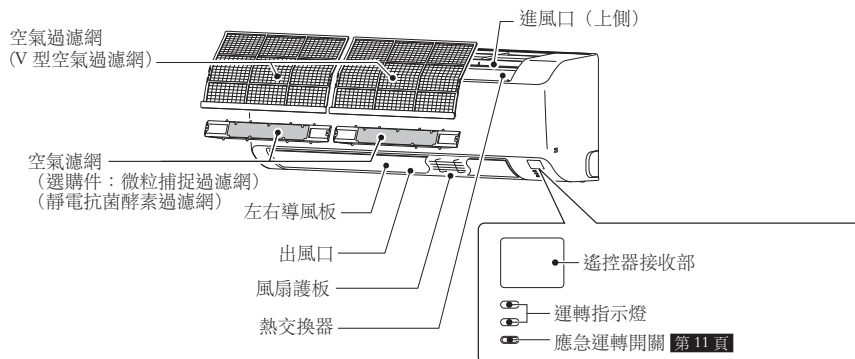

### <JY24>

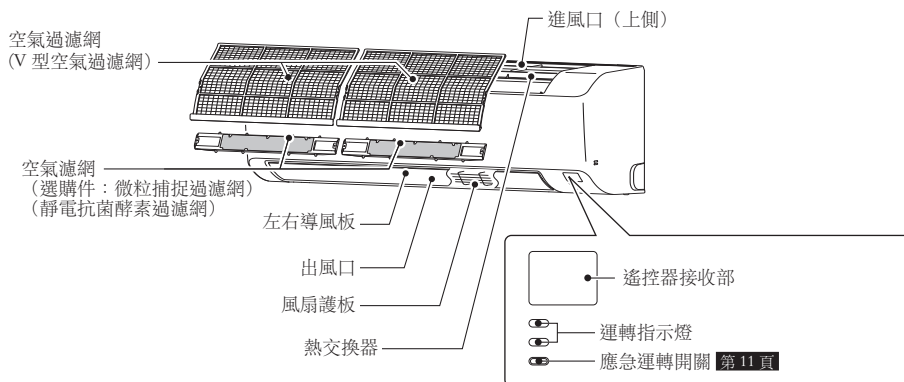

### 室外機組

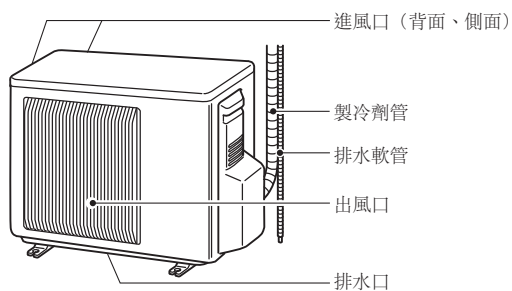

室外機組外觀可能不同。

Tc-5

## 各部件名稱

### 遙控器

信號發射部  
信號距離：約 6 m\*  
接收到信號時，室內機組會發出嗶聲。  
\* 有關錯誤代碼顯示模式，請參閱 第 17 頁。

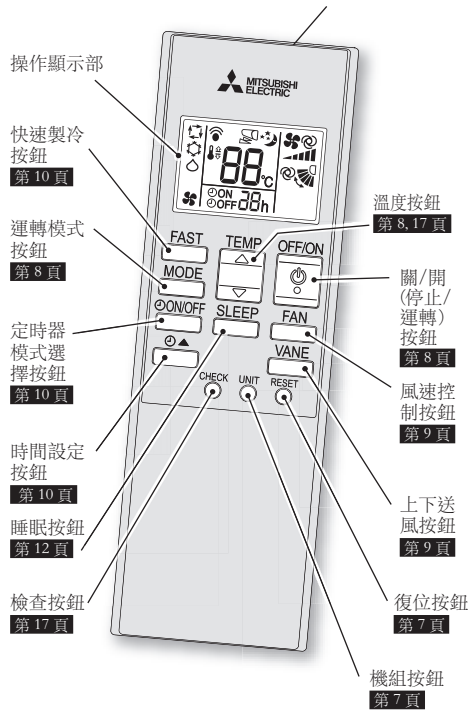

只能使用隨機組提供的遙控器。  
請勿使用其他遙控器。  
如果兩台或多台室內機組的安裝距離很近，不執行運轉的室內機組可能會回應遙控器。

### 遙控器吊鉤

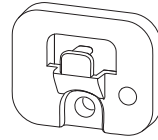

- 將遙控器吊鉤安裝在室內機組可接收到遙控器信號的位置。

## 操作前注意事項

操作前：將電源插頭插入電源插座和/或開啟斷電器。

### 安裝遙控器電池

1. 取下後蓋。

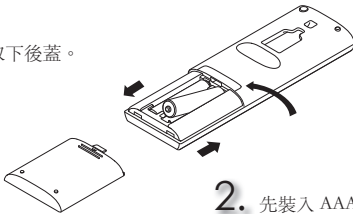

3. 裝回後蓋。

2. 先裝入 AAA 鹼性電池的負極。

4. 按下 [復位] 按鈕。

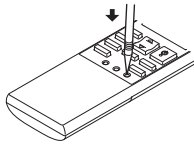

#### 註：

- 請確保電池的極性安裝正確。
- 請勿使用錳電池和漏液電池。否則遙控器可能故障。
- 請勿使用充電電池。
- 請使用同種類型的新電池更換。
- 電池壽命約為1年。但有效期已過期的電池可能壽命較短。
- 用尖細的物件輕輕按下 [復位] 按鈕。  
若沒有按下 [復位] 按鈕，遙控器可能無法正確運作。

#### 註：

##### 如何為室內機組專門設定遙控器

最多可用無線遙控器設定 4 部室內機組。

要使用每個遙控器單獨操作一部室內機組，請將室內機組的編號分配至每個遙控器。請依照下列流程設定：

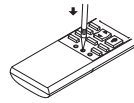

- (1) 關閉裝置的斷電器。
- (2) 遙控器電源關閉的情況下，按住遙控器上的 [機組] 2 秒鐘以進入配對模式。  
遙控器上會顯示出設定編號。
- (3) 再次按下 [機組]，為每個遙控器分配一個編號。  
每次按下 [機組]，編號即會以下列順序切換：1→2→3→4。

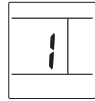

- (4) 按下  以完成配對設定。

開啟斷電器電源後，首先向室內機組傳送信號的遙控器，會被視為該室內機組的遙控器。

設定完成後，室內機組只會從獲分配的遙控器處接收到信號。

若斷電器關閉或電力供應中斷，室內機組的設定即會被取消。

## 選擇運轉模式

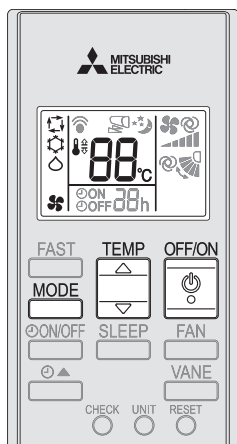

1 按下 開始運轉。

2 按下 選擇運轉模式。每按一次，將按照下列順序改變模式：

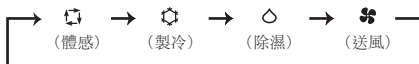

3 按下 或 設定溫度。每按一次，溫度會升高或降低 1°C。

按下 停止運轉。

• 下次按下，會選擇使用相同的設定 。

註：

### 運轉指示燈

運轉指示燈會顯示機組的運轉狀態。

指示燈	運轉狀態	室溫
	機組正在運轉，以達到設定的溫度	距離設定溫度約 2°C 或以上
	室溫接近設定溫度	距離設定溫度約 1 到 2°C

亮起    沒有亮起

## 體感模式

選擇了體感模式時，機組將根據室溫來選擇運轉模式。當室溫高於 25°C 時，會選擇製冷（設定溫度：24°C）。當室溫低於 25°C 時，會選擇除濕。但是，如果在停止運轉之後 2 小時之內啟動，會以之前選擇的模式運轉。

註：

在製冷運轉期間，當室溫高於設定的溫度 2°C 以上時，設定的溫度可能不會改變。在這種情況下，請等待室溫下降到設定的溫度 2°C 之內。

## 製冷模式

根據所需的溫度進行製冷。

## 除濕模式

對室內進行除濕。可能感覺室內較涼爽。除濕模式時，無法設定溫度。

## 送風模式

使室內空氣循環流通。

## 風速及風向調節

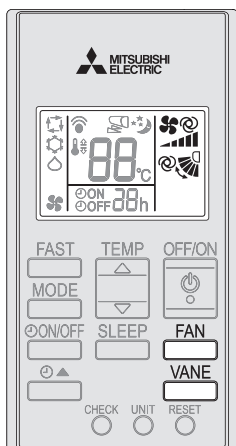

### 風速

1 按下 **FAN** 來選擇風速。每按一次，將按照下列順序改變風速：



- 設定為自動時，室內機組會發出兩聲短嗶聲。
- 使用較高的風扇速度，更強力地為房間製冷。建議在房間變涼後降低風扇速度。
- 使用較低的風扇速度，使運轉更安靜。
- 使用較低的風扇速度，進一步降低出風口溫度和濕度。

### 上下送風方向

1 按下 **VANE** 選擇風向。每按一次，將按照下列順序改變風向：

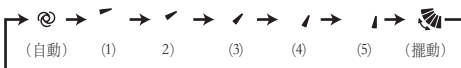

- ⊙ (自動) .....導風板會設定為最有效率的風向。：水平位置。
  - ☂ (手動) .....為了有效調節空氣溫度，請為製冷/乾燥選擇較上的位置，為風扇/製熱選擇較下的位置。若製冷/乾燥期間選擇了較下的位置，導風板會在 0.5 至 1 小時後自動移至較上位置，以防止任何凝結水珠滴落。
  - ☂ (擺動) .....導風板會間歇性地上下擺動。
- 設定為自動時，室內機組會發出兩聲短嗶聲。

### 左右送風方向

改變左右風向。

開始操作前，通過箭頭指示標籤將上下導風板從一側移至另一側。

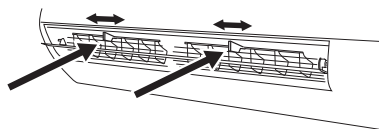

## 快速製冷運轉

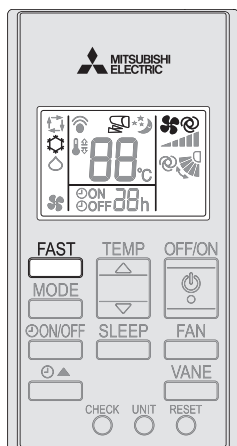

- 1 在製冷模式 **FAST** 期間按下，以開始快速製冷運轉。

風扇速度：快速製冷模式的專屬速度  
水平導風板：葉片會跟隨你的手動/擺動選擇而運轉。  
自動運轉期間的專屬位置。

- 快速製冷運轉期間無法設定溫度。

再次按下 **FAST** 以取消快速製冷運轉。

- 15 分鐘過後，或者按下 [運轉模式] 按鈕、[關/開 (停止/運轉)] 按鈕、[風速控制] 按鈕，快速製冷運轉即會被取消。

## 定時運轉 (定時開/定時關)

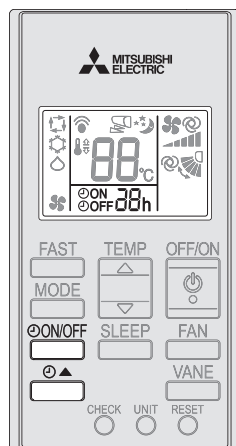

- 1 在運轉期間按下 **ON/OFF**，設定定時器。  
每按一次，按照下列順序改變定時器模式：

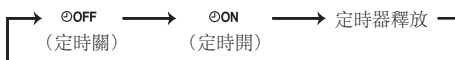

- 2 按下 **▲** 來設定定時的時間。  
按下使設定時間增加 1 小時。

按下 **ON/OFF**，直至出現「定時器釋放」，以釋放定時器。

### 註：

- 定時關和定時開不可聯合使用。
- 如果在設定定時開/關時發生斷電，請參閱 第 11 頁的「自動重新啟動功能」。

## 應急運轉

### 遙控器無法使用時...

可以按下室內機組上的應急運轉開關 (E.O. SW)，以啟動應急運轉。

<JY09/12/18/24>



每按一次 E.O. SW，將按照下列順序改變運轉模式：

運轉指示燈

應急製冷



停止

設定溫度：24℃  
風速：中等  
左右導風板：自動

#### 註：

運轉開始後的前 30 分鐘為試運轉。溫度控制不會運作，且風速設定為高速。

## 睡眠操作

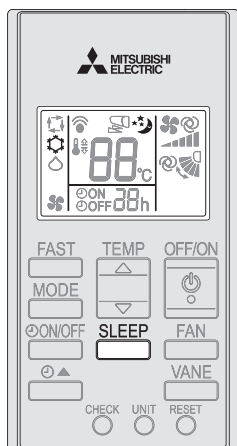

1

在 **SLEEP** 製冷模式 **第 8 頁** 期間按下，以開始睡眠運轉。

- 設定溫度會隨著時間而變化。
- 設定溫度會被控制至略低的水平，為時約 2 小時。這有助您更容易入眠。
- 風向可根據您的喜好更改。
- 定時開按鈕處於待機模式時，無法設定睡眠運轉。

睡眠模式開啟

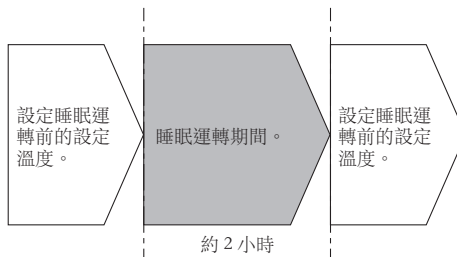

再次按下 **SLEEP** 以取消睡眠運轉。

- 按下 [運轉模式]、[快速]、[關/開] 或 [定時開按鈕] 按鈕時，睡眠運轉亦會被取消。

## 清潔

### 指示：

- 清潔前，請切斷電源或關閉斷電器。
- 請勿用手碰觸金屬零件。
- 請勿使用石油醚、稀釋劑、磨光粉或殺蟲劑。
- 污垢突出時，將廚房中性洗滌劑用溫水稀釋至規定濃度，再清洗，然後用濕毛巾擦去洗滌劑。
- 請勿將零件放在陽光直射、靠近熱源或火源的地方進行晾乾。
- 請勿使用溫度高於 50°C 的熱水。
- 請勿使用硬毛刷、硬海綿或類似物品。
- 請勿將水平導風板浸在水中或用水沖洗。
- 請勿對風扇用力過猛，否則可能會斷開或破裂。

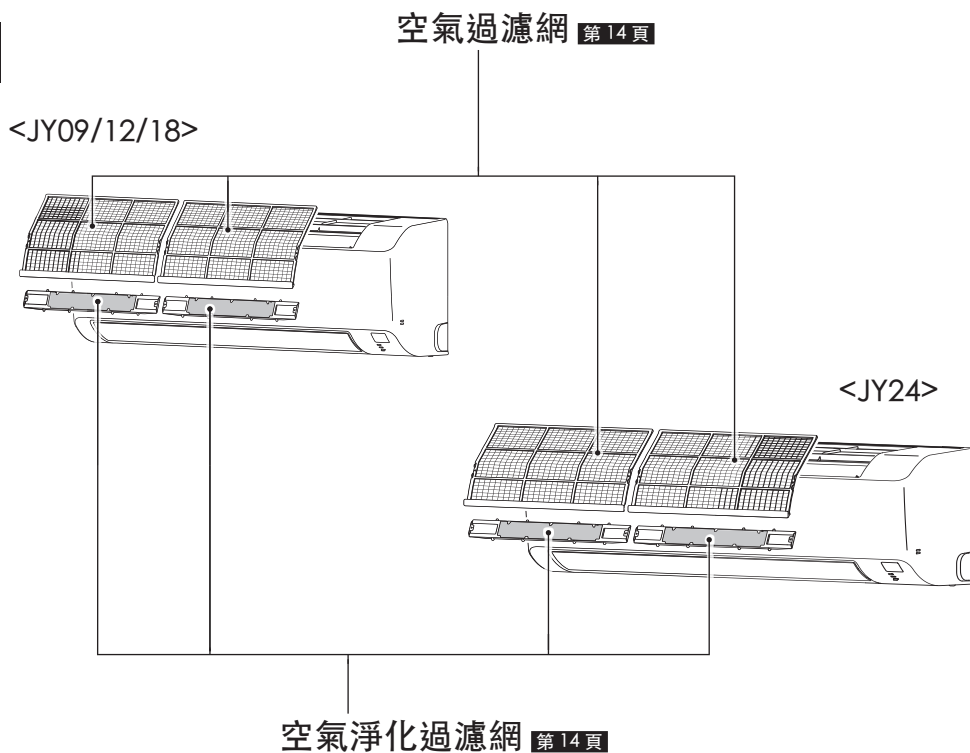

## 清潔

### 空氣過濾網 (V 型空氣過濾網)

#### • 每 2 週清潔一次

- 使用吸塵器掃除灰塵或水洗。
- 水洗淨後，請放在陰涼處晾乾。
- V 型空氣過濾網具有抑菌毒塗層，不僅可以改善空氣質量，還可以消除細菌和病毒。

### 空氣淨化過濾網 (選購件：微粒捕捉過濾網)

透過靜電移除空氣中的微粒。

#### 空氣過濾網反面

每 3 個月：

- 使用吸塵器掃除灰塵。
- 請勿用水清洗。上面黏附香煙的焦油或油垢時，請更換新的空氣淨化過濾網。
- 將其放回原來位置，並安裝空氣淨化過濾網的所有護耳。

每 3 年：

- 更換新的空氣淨化過濾網，以維持最佳效能。

零件編號

JY09/12/18 : MAC-EMF915FT-E (有框架)

: MAC-EMF925FT-E (無框架)

JY24 : MAC-EMF815FT-E (有框架)

: MAC-EMF925FT-E (無框架)

### 空氣淨化過濾網 (靜電抗菌酵素過濾網)

#### 空氣過濾網反面

每 3 個月：

- 使用吸塵器掃除灰塵。
- 將其放回原來位置，並安裝空氣淨化過濾網的所有護耳。

使用吸塵器無法掃除灰塵時：

- 清洗前，將過濾網及其框架浸入溫水。
- 洗淨後，放在陰涼處晾乾。安裝空氣過濾網的護耳。

每年：

- 更換新的空氣淨化過濾網，以維持最佳效能。

零件編號

JY09/12/18 : MAC-2322FT (有框架)

: MAC-2321FT (無框架)

JY24 : MAC-2323FT (有框架)

: MAC-2321FT (無框架)

#### <JY09/12/18>

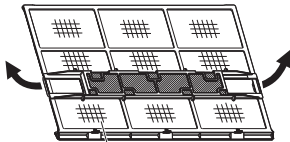

拆下兩側掛鉤及空氣過濾網。

#### <JY24>

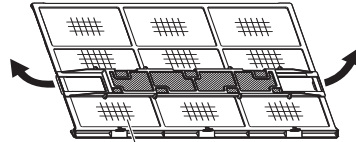

拆下兩側掛鉤及空氣過濾網。

#### ! 重要

- 請定期清潔過濾網，以維持最佳效能，並降低耗電量。
- 過濾網髒污會造成冷暖氣機中的水氣凝結，導致滋生霉菌等細菌。建議每 2 週清潔一次空氣過濾網。

## 疑難排解疑難排解

檢查上述項目後，機組仍無法恢復運轉，請停止使用冷暖氣機，並聯絡經銷商。

症狀	說明及檢查點
<b>室內機組</b>	
機組不運轉。	<ul style="list-style-type: none"> <li>斷電器是否已開啟？</li> <li>電源插頭是否已插入？</li> <li>是否設定了定時開？ <b>第 10 頁</b></li> </ul>
左右導風板不擺動。	<ul style="list-style-type: none"> <li>是否已正確安裝左右導風板及上下導風板？</li> <li>風扇護罩是否變形？</li> </ul>
重新啟動約 3 分鐘內，機組仍無法運轉。	<ul style="list-style-type: none"> <li>根據微型處理器的指示，這是保護機組。請稍等。</li> </ul>
室內機組的出風口吹出霧氣。	<ul style="list-style-type: none"> <li>室內空氣中的水份遇到從機組出風口吹出的冷風而迅速凝結成霧氣。</li> </ul>
左右導風板擺動一會兒，又重新啟動。	<ul style="list-style-type: none"> <li>這是為了正常執行左右導風板的擺動送風。</li> </ul>
運轉期間自行改變風向。 遙控器無法調節左右導風板的方向。	<ul style="list-style-type: none"> <li>機組在製冷或除濕模式運轉時，如果空氣往下吹持續半小時至1小時，風向自動設定為向上位置，以防止滴水。</li> </ul>
當主電源被開啟但尚未與遙控器一起操作時，本機組將自行開始運轉。	<ul style="list-style-type: none"> <li>這些型號配備有自動重新啟動功能。當關閉主電源而不用遙控器停止本機組然後再次開啟時，本機組將以關閉主電源前使用遙控器設定的相同模式自動開始運轉。請參閱的「自動重新啟動功能」。 <b>第 11 頁</b></li> </ul>
儘管如紫外線、溫度等因素會導致塑膠發黃，但對產品功能並無影響。	<ul style="list-style-type: none"> <li>儘管如紫外線、溫度等因素會導致塑膠發黃，但對產品功能並無影響。</li> </ul>
<b>室外機組</b>	
即使壓縮機運轉時，室外機組的風扇仍不會旋轉。即使風扇開始旋轉，亦很快會停止。	<ul style="list-style-type: none"> <li>製冷運轉期間若室外溫度變低，風扇會間歇地運轉以維持足夠的製冷能力。</li> </ul>
室外機組漏水。	<ul style="list-style-type: none"> <li>製冷及除濕模式期間，管道及其接頭部分會因冷卻而引起水氣凝結。</li> </ul>
<b>遙控器</b>	
遙控器不顯示或模糊不清。室內機組未回應遙控器的信號。	<ul style="list-style-type: none"> <li>電池電量是否已耗盡？ <b>第 7 頁</b></li> <li>電池的正負極 (+, -) 是否正確安裝？ <b>第 7 頁</b></li> <li>是否按下其他電器的遙控器按鈕？</li> </ul>

## 疑難排解疑難排解

症狀	說明及檢查點
<b>不要冷卻</b>	
無法充分製冷。	<ul style="list-style-type: none"> <li>• 溫度設定是否適當？ <b>第 8 頁</b></li> <li>• 風扇設定是否適當？請將風速變更為高速或超高。 <b>第 9 頁</b></li> <li>• 過濾網是否乾淨？ <b>第 13 頁</b></li> <li>• 室內機組的風扇或熱交換器是否乾淨？</li> <li>• 室內/室外機組的進風口或出風口是否堵塞？</li> <li>• 門窗是否打開？</li> <li>• 如果室內正在使用通風扇或爐具，製冷負荷會加重，導致製冷效果不佳。</li> <li>• 室外溫度過高時，製冷效果也不足。</li> <li>• 視房間大小及環境溫度等因素而定，設定溫度可能要在一段時間之後才能達到或可能無法達到。</li> </ul>
<b>氣流</b>	
室內機組吹出的氣流有異味。	<ul style="list-style-type: none"> <li>• 過濾網是否乾淨？ <b>第 13 頁</b></li> <li>• 室內機組的風扇或熱交換器是否乾淨？</li> </ul> 機組可能吸入了牆壁、地毯、家具及衣物等的異味，並隨著空氣吹出。
<b>聲音</b>	
聽到「噼啪」聲。	<ul style="list-style-type: none"> <li>• 前面板等零件因溫度變化而熱脹冷縮時產生的聲音。</li> </ul>
聽到「氣泡」聲。	<ul style="list-style-type: none"> <li>• 開啟吸油煙機或通風扇時，從排水軟管吸入外部空氣，使排水軟管內水流排出而發出的聲音。</li> <li>• 如果室外風力很大，外部空氣吹入排水軟管，也會聽到這種聲音。</li> </ul>
室內機組發出「咯吱咯吱」聲。	<ul style="list-style-type: none"> <li>• 開啟/關閉風扇或壓縮機時的切換聲音。</li> </ul>
室內機組發出「咯吱咯吱」聲。	<ul style="list-style-type: none"> <li>• 開啟/關閉風扇或壓縮機時的切換聲音。</li> </ul>
聽到水流聲。	<ul style="list-style-type: none"> <li>• 這是機組內製冷劑或凝結水流動的聲音。</li> </ul>

在下列情況下，請停止使用冷暖氣機，並聯絡經銷商。

- 室內機組漏水或滴水。
- 左/上方的運轉指示燈閃爍。 **第 17 頁**  
當機組處於待機模式，而多機組的指示燈閃爍時除外。
- 斷電器經常故障。
- 如果室內使用電氣開/關型熒光燈（倒相熒光燈等），機組可能接收不到遙控器的信號。
- 機器運轉時可能會干擾電台或電視信號接收。受影響的設備可能需要加裝信號放大器。
- 聽到異常聲音。
- 如有製冷劑洩漏。

## 安裝位置及配電

室內機組左/上方運轉指示燈閃爍時，可查看遙控器顯示屏上的錯誤代碼。

請依照下列流程檢查錯誤代碼。

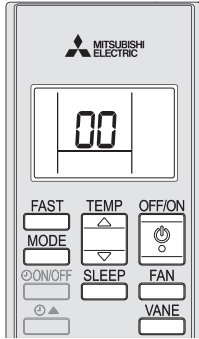

示例：錯誤代碼 (00)

### 1 錯誤代碼顯示

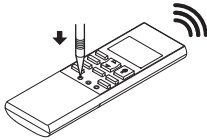

- 遙控器的電源為關閉。
- 靠近室內機組的正前方，將遙控器指向室內機組的接收部，並用尖頭物件持續按下 [檢查]。
- 顯示屏上會顯示「00」。
- 繼續將遙控器指向室內機組的接收部，直至室內機組發出嗶聲。
- 若室內機組並未發出嗶聲，再靠近室內機組一點，並再次按住 [檢查]。
- 若室內機組依然沒有發出嗶聲，請關閉如螢光燈和電視等可能發出噪音之電器的電源，然後再試一次。(若電池更換指示燈亮起，請更換新電池。)
- 當遙控器的顯示屏上出現「00」，而室內機組發出 2 下嗶聲時，即代表機組並無故障。
- 當遙控器的顯示屏上出現「00」，而室內機組發出 1 下嗶聲時，即代表機組有故障。請依照下列步驟操作以診斷錯誤。

### 2 錯誤代碼檢查

按下 或 ，以更改錯誤代碼。

每次按下 ，遙控器上顯示的錯誤代碼 即會以升序 (A 至 Z) 變更，具體如下。

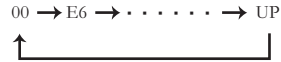

每次按下 ，錯誤代碼則會以降序 (Z 至 A) 變更。

1 個 1 個地檢查錯誤代碼以傳送信號。

室內機組發出 2 下嗶聲

：機組發生與錯誤代碼相對應的故障。請參閱錯誤代碼表，以確認異常位置。

室內機組發出 1 下嗶聲

：機組並無故障。重覆檢查。

室內機組沒有發出嗶聲

：診斷失敗。請再試一次。

• 當機組發生故障時，需要檢查及維修冷暖氣機。請停止使用冷暖氣機，關閉斷電器電源，並聯絡經銷商。

### 註：

按下 或 以外的其他按鈕會取消遙控器的錯誤代碼顯示模式。

若在運轉指示燈沒有閃爍時運轉遙控器，可能不會顯示出準確的錯誤代碼。

## 安裝位置及配電

### 遙控器的錯誤代碼

物件	代碼	異常位置	
	00	無 (正常)	
室內機組	E6	序列信號	
	E7		
	Fb	室內控制系統	
	P1	室溫熱敏電阻	
	P2	室內線圈熱敏電阻	
	P9		
	Pb		
室外機組	E8	室內/外通訊、接收錯誤	
	E9		
	EC		
	FC	非揮發性記憶體數據	
	Fd	差異電壓	
	P8	四通閥/管道溫度	
	PL	室外製冷劑系統	
	U3	排水溫度熱敏電阻	
	U4		除霜熱敏電阻
			導風板溫度熱敏電阻
			印製電路板溫度熱敏電阻
			周圍溫度熱敏電阻
			室外熱交換器溫度熱敏電阻
	UE	停止閥 (閉合閥)	
	UP	室外電力系統	

## 冷暖氣機長時間不使用時

- 1 以製冷模式運轉並設定最高的溫度，或以風扇模式運轉 3 至 4 小時。

### 第 8 頁

- 這可除去機組內部的濕氣。
- 冷暖氣機內的濕氣會導致如霉菌等真菌滋生。

- 2 按下  停止運轉。

- 3 關閉斷電器及/或拔下電源插頭。

- 4 取出遙控器中的所有電池。

## 再次使用冷暖氣機時：

- 1 清潔空氣過濾網。 **第 13 頁**

- 2 確認室內/室外機組的進風口和出風口是否堵塞。

- 3 確認已正確連接地線。

- 4 請參閱「操作前注意事項」，並按照指示進行。 **第 7 頁**

## 安裝位置及配電

### 安裝位置

請避免將冷暖氣機安裝在下列位置。

- 放置較多機油。
- 海邊等鹽分較多。
- 溫泉、污水、廢水等產生硫化氣體。
- 會濺出油份或充滿油煙（如廚房和工廠，機組的塑膠特性可能會改變，甚至損壞）。
- 放置高頻或無線器材。
- 室外機組出風口受到阻塞。
- 運轉聲音或室外機組出風時影響到鄰居。
- 建議室內機組的安裝高度為 1.8 m ~ 2.3 m。現場如有困難，請聯絡經銷商。
- 室內機組必須安裝在超出額定樓面空間的房間內。請聯絡經銷商。
- 室內工程和裝修期間，或者地板打蠟時，請勿運轉冷暖氣機。進行該等工作後，運轉冷暖氣機前請先為房間妥善通風。否則，揮發性元素可能會黏附在冷暖氣機內部，導致漏水或凝露積聚。

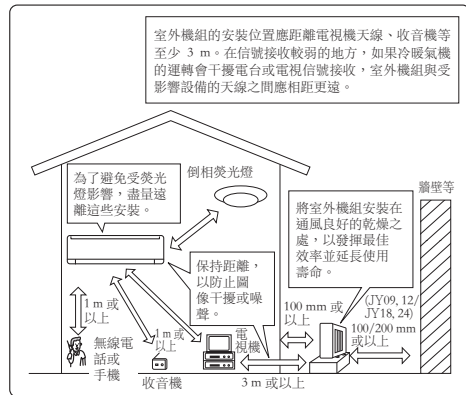

### 配電

- 冷暖氣機的電源應使用專用電路。
- 請務必注意斷電器容量。

若您有任何問題，請聯絡經銷商。

## 規格

模型		MSY-JY09VF	MSY-JY12VF	MSY-JY18VF
方面	室內	290 × 799 × 233	290 × 799 × 233	290 × 799 × 233
高 × 寬 × 深 (mm)	室外	454 × 660 × 235	454 × 660 × 235	538 × 699 × 249
重量 (kg)	室內	8.7	8.7	9.3
	室外	17.2	20.3	25.7

模型		MSY-JY24VF
方面	室內	290 × 999 × 233
高 × 寬 × 深 (mm)	室外	714 × 800 × 285
重量 (kg)	室內	11.3
	室外	28.1

### 適用環境溫度範圍

	室內	室外
上限	32°C DB 23°C WB	46°C DB —
下限	21°C DB 15°C WB	21°C DB —

DB: 乾球  
WB: 濕球

# **MITSUBISHI ELECTRIC CORPORATION**

HEAD OFFICE: TOKYO BUILDING, 2-7-3, MARUNOUCHI, CHIYODA-KU, TOKYO 100-8310, JAPAN

VG79Y863H02